

TRANSPORT Global Practice Working Paper

Synopsis of Bank-Funded Bus Rapid Transport Projects

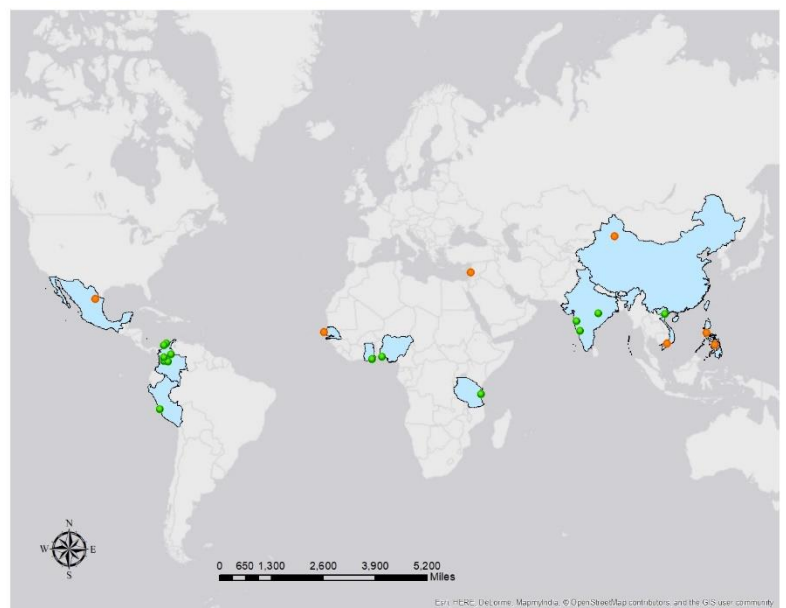
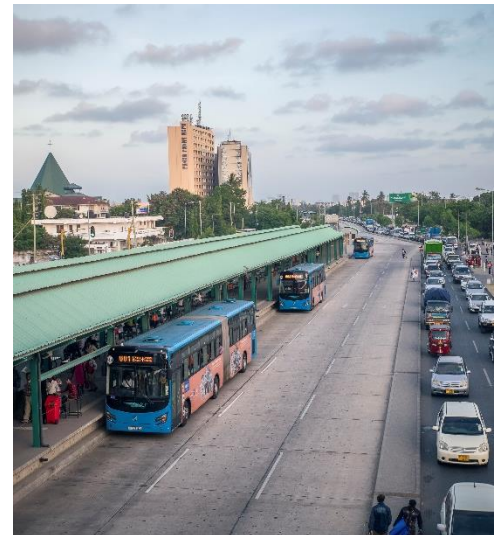

©2020 Transport Global Practice

International Bank for Reconstruction and Development / The World Bank
1818 H Street NW, Washington DC 20433

Internet: <http://www.worldbank.org/transport>

Standard Disclaimer

This work is a product of the staff of The International Bank of Reconstruction and Development / World Bank. The findings, interpretations, and conclusions expressed in this work do not necessarily reflect the views of Executive Directors of the World Bank or the governments they represent. The World Bank does not guarantee the accuracy of the data included in this work. The boundaries, colors, denominations, and other information shown on any map in this work do not imply any judgment on the part of The World Bank concerning the legal status of any territory or the endorsement or acceptance of such boundaries.



This work is available under the Creative Commons Attribution 3.0 IGO license (CC BY 3.0 IGO) <http://creativecommons.org/licenses/by/3.0/igo>. Under the Creative Commons Attribution license, you are free to copy, distribute, transmit, and adapt this work, including for commercial purposes, under the following conditions:

Attribution

Please cite the work as follows: World Bank Transport Global Practice. 2020. Working Paper: Synopsis of Bank-Funded Bus Rapid Transport Projects. World Bank, Washington, DC.

Translations

If you create a translation of this work, please add the following disclaimer along with the attribution: This translation was not created by the Transport unit or the World Bank and should not be considered an official World Bank translation. Transport and the World Bank shall not be liable for any content or error in this translation.

Adaptations

If you create an adaptation of this work, please add the following disclaimer along with the attribution: This is an adaptation of an original work by The World Bank. Views and opinions expressed in the adaptation are the sole responsibility of the author or authors of the adaptation and are not endorsed by The World Bank.

Copyright Statement

The material in this publication is copyrighted. Copying and/or transmitting portions or all this work without permission may be a violation of applicable law. The International Bank for Reconstruction and Development/The World Bank encourages dissemination of its work and will normally grant permission to reproduce portions of the work promptly.

This page intentionally left blank

CONTENTS

ACKNOWLEDGEMENTS	13
EXECUTIVE SUMMARY	15
PART 1. OVERVIEW OF BANK-FINANCED BRT PROJECTS	33
1. Purpose and Use of the Document	35
1.1. Objectives	35
1.2. Background	35
1.3. Use of the Document	35
2. Overarching Framework of the Research	36
3. Limitations of the Document	37
4. City Inventory Selection and Summary	37
4.1. Inventory Approach	38
4.2. Introduction of World Bank’s Investment Project Development and Financing	40
4.3. Financing of Completed BRT IPFs	41
4.4. Years of Implementation	42
PART 2. BRT CASE STUDIES	45
5. Accra, Ghana	47
5.1. City and Urban Transport Context	47
5.2. Project Development Objectives and Schedule	48
5.3. Case Analysis: Government Commitment	48
5.4. Case Analysis: Modification of BRT to QBS	49
5.5. Case Analysis: Institutional Deficiencies	50
5.6. Case Analysis: Lessons Learned	51
6. Bogotá, Colombia (UTP & USP)	53
6.1. City and Urban Transport Context	53
6.2. Project Development Objectives and Schedule	54
6.3. Case Analysis: BRT System Design	56
6.4. Case analysis: Operations Management – key features	57
6.5. Case Analysis: Institutional Arrangement	57
6.6. Case Analysis: Financing CAPEX	58
6.7. Case Analysis: Financing OPEX	59
6.8. Case Analysis: Expansion Challenges and Evolving Issues	60
6.9. Case Analysis: Lessons Learned	61
7. Colombian National Urban Transport Program (6 Cities)	65
7.1. National Program Introduction	65
7.2. Project Development Objectives and Schedule	66
7.3. Pereira (Megabus)	66
7.4. Barranquilla (Transmetro)	68
7.5. Bucaramanga Metrolinea	70
7.6. Medellín (Metroplus)	72
7.7. Cartagena (TransCaribe)	74
7.8. Summary of Colombia Cities (Excluding Bogotá)	76
7.9. Case Analysis: Lessons Learned	77

8.	Dar es Salaam, Tanzania	79
8.1.	City and Urban Transport Context.....	79
8.2.	Project Development Objectives and Schedule.....	80
8.3.	Case Analysis: BRT System Design.....	80
8.4.	Case Analysis: Operations Management.....	81
8.5.	Case Analysis: Impacts of DART BRT on Paratransit.....	83
8.6.	Case Analysis: Lessons Learned.....	83
9.	Hanoi, Vietnam	85
9.1.	City and Urban Transport Context.....	85
9.2.	Project Development Objectives and Schedule.....	86
9.3.	Case Analysis: BRT System Design.....	87
9.4.	Case Analysis: Operations Management.....	88
9.5.	Case Analysis: Government Commitment.....	89
9.6.	Case Analysis: Institutional Arrangement.....	89
9.7.	Case Analysis: Lessons Learned.....	89
10.	India Three BRT Cities	93
10.1.	Multicity Program Introduction.....	93
10.2.	Project Development Objectives and Schedule.....	94
10.3.	Hubli-Dharwad.....	95
10.4.	Naya Raipur.....	96
10.5.	Pimpri-Chinchwad.....	97
10.6.	Case Analysis: Government Commitment.....	98
10.7.	Case Analysis: Institutional Arrangements and Operations Management.....	99
10.8.	Implementation Experience.....	100
10.9.	Case Analysis: Lessons Learned.....	101
11.	Lagos, Nigeria	103
11.1.	City and Urban Transport Context.....	103
11.2.	Project Development Objectives and Schedule.....	104
11.3.	Case Analysis: BRT Design.....	104
11.4.	Case Analysis: Government Commitment.....	107
11.5.	Case Analysis: LAMATA as the Urban Transport Authority.....	107
11.6.	Case Analysis: Operations Management.....	109
11.7.	Case Analysis: Lessons Learned.....	111
12.	Lima, Peru	113
12.1.	City and Urban Transport Context.....	113
12.2.	Project Development Objectives and Schedule.....	114
12.3.	Case Analysis: BRT System Design.....	114
12.4.	Case Analysis: Government Commitment.....	115
12.5.	Case Analysis: Institutional Arrangement.....	116
12.6.	Operations Management.....	116
12.7.	Case Analysis: Impacts on the Poor.....	117
12.8.	Case Analysis: Implementation Experience.....	118
12.9.	Case Analysis: Lessons Learned.....	119
PART 3.	BRT DESIGN CONSIDERATIONS	121
13.	Introduction	123

14. Practical Insights into BRT Applications	125
14.1. Weighing up the BRT Brand - What it Represents	126
14.2. Being Practical on BRT Capacity.....	129
14.3. Understanding the Political Dimension	132
15. The Software of BRT – Institutions, Operations Management, Financial Sustainability	137
15.1. Developing BRT Institutional Capacity.....	138
15.2. Securing Bus Operators	142
15.3. Leveraging BRT to Spearhead Sector Reform	147
15.4. Achieving Financial Sustainability – The Business Case	155
15.5. Setting Fares and Affordability for The Poor	160
16. The Infrastructure and Operational Design of BRT	163
16.1. Integrating Infrastructure, Operations and Network	164
16.2. Assessing the BRT Standard Scoring System.....	165
16.3. Adapting Design to Local Conditions	166
16.4. Selection of the First Corridor.....	167
16.5. Choosing Median or Curbside Alignment	168
16.6. Choosing a Closed or Open System	170
16.7. Managing Intersection Control.....	171
16.8. Designing Stations	172
16.9. Developing BRT in Medium-sized Cities	174
16.10. Conclusion	175
REFERENCE LIST	177

Figures

Figure 1.2-1: Research Framework and Flow	36
Figure 4.1-1: Locations of Bank-Financed BRT Projects	39
Figure 4.2-1: IPF Project Cycle	41
Figure 4.3-1: Project Financing at Completion (Converted to U.S.\$)	42
Figure 4.4-1: Timeline of BRT Projects by Completion Year (as of September 2018)	42
Figure 4.4-2: Years of Implementation (Actual vs. Original Plan)	43
Figure 6.2-1: Bogotá's BRT Phase 1 & 2 Photos	54
Figure 6.2-2: Map of the Full TransMilenio Network	55
Figure 6.8-1: Bus Congestion on the Busway	61
Figure 6.8-2: Congestion Affecting Service Efficiency	61
Figure 7.4-1: BRT Routes in Pereira (2015)	66
Figure 7.5-1: BRT Routes in Barranquilla.....	68
Figure 7.6-1: BRT Routes in Bucaramanga	70
Figure 7.7-1: BRT Network in Medellín	72
Figure 7.7-2: Medellín Metro	73
Figure 7.7-3: Tranvía tramcar line T-A.....	73
Figure 7.7-4: Tranvía Tramcar Line.....	74
Figure 7.7-5: Civica Integrates Fare system	74
Figure 7.8-1: BRT Network in Cartagena	75
Figure 7.8-2: BRT station - Accessible and Air-Conditioned	76
Figure 7.8-3: Pre-Troncal Bus	76
Figure 8.3-1: Phase 1 BRT corridor	80
Figure 8.3-1 & 8.3-2 Inner City Bus Congestion	81
Figure 8.3-2: Bus Station	81
Figure 8.3-4 Overcrowding on DART BRT (2018)	81
Figure 9.2-1: Map of Planned BRT lines	87
Figure 9.7-1: Need for hard barrier	91
Figure 9.7-2: BRT lane invasion	91
Figure 9.7-3: Lack of traffic enforcement.....	91
Figure 9.7-4: Mixed traffic operation on an overpass.....	91
Figure 9.7-5: improved discipline of traffic violators is needed	91
Figure 9.7-6: Ignorance of BRT rules is an accident risk	91
Figure 10.2-1: BRT in Project Cities	94
Figure 10.3-1. Hubli-Dharwad BRT	95
Figure 10.4-1. Naya Raipur BRT.....	96
Figure 10.5-1. Pimpri-Chinchwad BRT.....	97
Figure 11.3-1: An Artist's Rendering of BRT-Lite Corridor (before and after)	105
Figure 11.3-2: BRT Lite Corridor	106
Figure 11.3-3: Comparison of Phase 1 BRT Lite (Left) and Phase 2 BRT (Right)	106
Figure 11.3-4: Phase 2 New BRT Corridor to Extend the BRT Lite Corridor	107
Figure 12.3-1: Lima's Metrolinea BRT	115
Figure 12.3-2: Trunk Route and Stations.....	115
Figure 14.1-1: The Diverse Elements in the Urban Mobility Toolbox	126
Figure 14.1-2: Guangzhou BRT	129
Figure 14.1-3: Hanoi BRT.....	129
Figure 14.2-1 TransMilenio (rush hour)	130

Figure 14.2-2: TransMilenio (rush hour)	130
Figure 14.2-3: Six-Step Sequence for the Rapid Transit Alternative Analysis	132
Figure 14.3-1: Example of a Public Transport Strategic Policy Framework	134
Figure 15.1-1: Core Requirements in Setting Up a UTA	138
Figure 15.1-2: Tiered Level of Functions and Risk Assignment Among Players	139
Figure 15.1-3: Typical Functions of a BRT Agency	140
Figures 15.1-4/5: Organic Growth of the TransMilenio Organisation	141
Figure 15.2-1: Deciding on Contract Types Based on Relative Capacity of the Parties	144
Figure 15.2-2: Methodologies used to Transition to New Contract Models	145
Figure 15.2-3: Steps of the Transition Process	147
Figure 15.3-1: A 5-step transition process formalizing paratransit	150
Figure 15.3-2: Bus Lines Using BRT Lanes (Argentina)	152
Figure 15.3-3: Pointers for Engaging with Traditional Bus Operators	154
Figure 15.4-1: Input and Output of An Operations Cost (OPEX) Model	159
Figure 16-1.1: 'Hardware' of BRT	164
Figure 16.1-2: Elements of Operations Planning	164
Figure 16-3.1: Buenos Aires BRT (Argentina)	167
Figure 16.4-1: Peak-Hour Bus Lanes	169
Figure 16.6-1: Illustration of Closed and Open System Design	170
Figure 16.8-1: Kalideres Station on TransJakarta	172
Figure 16.8-2: Dukuh Atlas Station TransJakarta	172
Figure 16.8-3: Double Sided Median Station	173
Figure 16.8-4: Split Median Station Across intersection	173
Figure 16.8-5: Curb Guidewheel	174
Figure 16.8-6: Precise docking with guidewheel system	174
Figure 16.8-7: Schematics and dimensions of guideway system	174
Figure 16.8-8: Splayed guiderail entry	174
Figure 16.9-1: Bus Priority and Integrated Corridor Management in Medium-Sized Cities	175

Tables

Table 4.1-1: Completed BRT IPF Projects By Approval Date (as of September 2018)	40
Table 4.1-2: Ongoing BRT IPF Projects by Approval Date (as of September 2018)	40
Table 6.2-1: Expansion of Bogotá's BRT in 3-Phases	55
Table 6.2-2: TransMilenio System Statistics 2017	56
Table 7.4-1: Pereira BRT Data	67
Table 7.5-1: Barranquilla Transmetro Data	69
Table 7.6-1: Metrolinea BRT Data	71
Table 7.7-1: Medellín BRT Data	73
Table 7.8-1: TransCaribe BRT Data	75
Table 14.1-1: The Range of BRT Infrastructure	128
Table 14.3-1: Political Risk Analysis and Mitigation	135

Acronyms

AFC	Automatic Fare Collection
AMB	Area Metropolitana de Barranquilla
AMCO	Central West Metropolitan Area (Pereira)
APCRUTA	Andhra Pradesh Capital Region Unified Transport Authority
AVLS	Automatic vehicle location system
BITS	Bogotá Integrated Transport System
BOT	Build-operate-transfer
BRT	Bus rapid transit
BUSP	Bogotá Urban Services Project
BUTP	Bogotá Urban Transport Project
CAS	Country Assistance Strategy
CAPEX	Capital Expenditure
CCTV	Closed-circuit television
CDM	Clean development mechanism
CONPES	National Economic and Social Council
CUT	Centre for Urban Transport (Accra)
Daladala	Minibus share taxis in Tanzania
DARCOBOA	Dar es Salaam Commuter Bus Owners Association
DART	Dar Rapid Transit
DPL	Development Policy Loan
EAP	East Asia and Pacific
EIRR	Economic internal rate of return
EMTVA	Medellín State-Owned Mass Transport Company
FCS	Fare collection system
FIRR	Financial internal rate of return
FTA	Federal Transit Administration U.S. Department of Transportation
GAPTE	Greater Accra Passenger Transport Executive
GCC	Gross-Cost Contract
GEF	Global Environment Facility
GEO	Global Environment Objective
GoC	Government of Colombia
GoG	Government of Ghana
Gol	Government of India
GoN	Government of Nigeria
GoP	Government of Peru
GoT	Government of Tanzania
GoV	Government of Vietnam
GPRTU	Ghana Private Road Transport Union
GTC	Generalized transport cost
GUTP	Ghana Urban Transport Project
HCMC	Ho Chi Minh City Vietnam
HDMC	Hubli-Dharwad Municipal Corporation
HPC	Hanoi Peoples Committee
HUTPMU	Hanoi Urban Transport Project Management Unit

IADB	Inter-American Development Bank
ICM	Integrated Corridor Management
ICR	Implementation Completion Results Report
IDA	International Development Association World Bank
IDB	Inter-American Development Bank
IDI	Urban Development Institute of Bogotá
IEG	Independent Evaluation Group World Bank
IMTS	Integrated Mass Transit Systems
INR	Indian rupee
IPF	Investment project financing
ITDP	Institute of Transport and Development
ITS	Intelligent transport systems
KM/km	Kilometers
KPI	Key performance indicator
LAC	Latin American countries
LAMATA	Integrated Public Transport System (the transport authority in Lagos)
LRT	Light Rail Transit
LSG	Lagos State Government
LUTP	Lagos Urban Transport Project
M&E	Monitoring and evaluation
MLGRD	Ministry of Local Government and Rural Development Ghana
MMDA	Metropolitan, Municipal, or District Assemblies (Accra)
MML	Metropolitan Municipality of Lima
MMTL	Metro Mass Transit Limited
MOT	Ministry of Transport
MoUD	Ministry of Urban Development
NCC	Net-Cost Contract
NMT	Non-motorized transport
NPV	Net present value
NURTW	National Union of Road Transport Workers
NUTP	National Urban Transport Program (Colombia)
O&M	Operations and Maintenance
OPEX	Operational Expenditure
OVE	Office of Evaluation and Oversight, Inter-American Development Bank
PAD	Project Appraisal Document
PCU	Project Coordination Unit
PDO	Project Development Objective
PPHPD	Passengers per hour/per direction
PIS	Passenger information systems
PPIAF	Public – Private Infrastructure Advisory Facility (a multi-donor technical assistance facility)
PPP	Public-Private partnership
PPPLRC	Public-Private-Partnership Legal Resource Center
PTA	Public Transport Authority or in some cities, Passenger Transport Authority
QBS	Quality bus service
R&D	Research and development
RAS	Reimbursable Advisory Services

RITMP	Red Integrada de Transporte Metropolitano
ROW	Right of way
SF	Secretariat of Finance (Bogotá)
SHB	District Finance Secretariat (Bogotá)
SITM	Sistema Integrado de Transporte Masivo (Integrated Mass Transit System)
SITP	Integrated Public Transport System
SM	Secretariat of Mobility (Bogotá)
SOE	State-owned enterprise (a publicly owned company)
SPTS	Strategic public transport systems
SPV	Special purpose vehicle (agency)
SSA	Sub-Saharan Africa
SST	Secretariat of Transit and Transportation (Bogotá)
STC /STU	State Transport Corporations (also referred to as a STU - State Transport Undertaking)
SUTP	Sustainable Urban Transport Project
TAL	Technical Assistance Loan
TfL	Transport for London
ToD	Transit-oriented development
ToR	Terms of Reference
TRAMOC	Hanoi Transport Management and Operation Center
TRANSERCO	Hanoi Bus State-owned enterprise
Tro	The shared taxis/buses in Accra Ghana
TRP	Taxi Recapitalization Programme
TTL	Bank Staffer – Task Team Leader
TUPWS	Transport and Urban Public Works Service
Tzs	Tanzanian shillings
UTA	Urban Transport Authority
UMGSG	The World Bank's Urban Mobility Global Solution Group
UDA-RT	Usafiri Salama Dar es Salaam Rapid Transit (bus operator)
UMTA	Unified Metropolitan Transport Authorities
UNDP	United Nations Development Program
UNESCO	The United Nations Educational, Scientific and Cultural Organization
UPTU	Urban Public Transport Unit
WB	World Bank
WRI	World Resources Institute

Acknowledgements

This report is supported by the World Bank's Transport Global Practice and the Urban Mobility Global Solutions Group of the Transport Global Practice; and funded by the Mobility and Logistics Multi Donor Trust Fund (MOLO). The report was prepared by a team led by Wenyu Jia, Senior Urban Transport Specialist. The authors are Frits Olyslagers (Public Transport and Institutional Specialist), Wenyu Jia, Leonardo Canon Rubiano (Urban Transport Specialist) and Zhen Liu (Research Analyst).

The report reviews the group of Bus Rapid Transit (BRT) Investment Project Financing (IPF) projects that the World Bank supported from the years 2000 through 2018. It draws on case studies of successes and lessons learned to inform practitioners and city managers who are considering BRT as an urban mobility intervention. The report aims to serve as a source of reference by providing practical guidance on BRT from planning to implementation to operations management.

This final report reflects the culmination of the generous and insightful efforts and contributions made by the contributors and reviewers. Contributors include the World Bank's BRT project task team leaders and authors of project completion reports: Fatima Arroyo, Mauricio Cuellar, Arturo Ardila-Gomez, Roger Gorham, Alejandro Hoyos Guerrero, Nupur Gupta, Akiko Kishiue, Yonas Eliesikia Mchomvu, Van Anh Thi Tran, and Jen Jung Eun Oh.

We give special thanks to Anthony (Dayo) Mobereola, the former Managing Director of Lagos Area Metropolitan Transport Authority, for insights on institutional development; and to Alejandro Hoyos Guerrero and Yonas Eliesikia Mchomvu for sharing research on BRT experiences in Colombia and Tanzania. The team benefited from in-depth interviews with project task team leaders working on the selected cases, including Camila Rodriguez and Mauricio Cuellar for the Colombia BRT, Nupur Gupta for the India BRT, and Van Anh Thi Tran and Yang Chen for the Hanoi BRT.

The World Bank's Urban Mobility Global Solution Group (UMGSG) leads, Arturo Ardila Gomez and Georges Bianco Darido, provided input and guidance on the draft report and conducted a thorough preview of the final draft. The World Bank's Transport Global Practice managers Benedict L.J. Eijbergen and Maria Marcela Silva provided the authors with encouragement and valuable guidance.

The team also received important comments from the following World Bank peer reviewers, listed in alphabetic order: Georges Bianco Darido (Lead Urban Transport Specialist), Nupur Gupta (Senior Transport Specialist), Camila Rodriguez Hernandez (Senior Infrastructure Specialist), and Ajay Kumar (Urban Transport Consultant).

This page intentionally left blank

Executive Summary

Purpose and Context of the Document

This document serves as an inventory and synopsis of the completed Bank-funded Bus Rapid Transit (BRT) projects from the year 2000 through September 2018. It documents findings related to select aspects discussed in the case study cities, including significant experiences, challenges, successes and lessons learned, to relay practical, ground-level guidance on BRT planning and implementation. This guide also serves to enrich the global body of knowledge related to BRT development and implementation. The target audience includes the World Bank's transport practitioners, client cities, partners, and stakeholders.

The World Bank's support for BRT initiatives has been extensive over the past two decades. It has involved institutional and regulatory reforms, public transport and network planning, alternatives analyses, corridor design, and bus operations. Synthesizing this experience from ground-level engagements and knowledge helps to draw out learnings for new projects under conceptualization.

Cities planning BRT frequently undertake study tours to other cities with BRT experience to gain first-hand knowledge of design, construction and operations. Although such tours can be insightful, they are resource intensive. This synopsis could serve as a resource to highlight key issues in BRT planning and implementation, and to guide the Bank's clients in selecting a BRT tour that resembles the context of their own cities, with a clearer focus on issues of interest.

Among the case study cities, the implementation of BRT corridors delivered a remarkable transformation in urban mobility, often replacing chaotic traditional transport systems and delivering tangible impacts on the city and its peoples. However, BRT implementation is a complex affair since it operates under political and economic imperatives and involves complex planning and design, adaption to local conditions, and extensive coordination of stakeholder engagement, institutional change, as well as project and financial risk management.

This document aims to conduct an honest and balanced appraisal of BRT experiences to understand the underlying reasons and causes for BRT system results, thus discussing both successes and lessons. In doing so, potentially optimistic or critical views may be apparent. The latter is not meant as criticism but to constructively consider issues that can guide future BRT projects. The review team fully understands that most BRT systems operate within a tangled web of politics, economic constraints, a steep learning curve, and extensive coordination. The authors acknowledge the efforts that cities across the globe make to innovate and transform urban mobility, and we salute decisionmakers and practitioners who support such projects with untiring efforts, commitment and sacrifice.

Research Framework and Limitations

This synopsis is primarily based on desktop research through a review of internal documents and external research. The authors acknowledge the limitations of this desktop review approach, such as the absence of granular analysis of dynamic, complex issues involved in each case study that could only be obtained through field visits and in-depth discussions with stakeholders.

Due to the complexity of BRT development, which intertwines planning, implementation, and operations phases, the authors have developed a logical order of framework by building on the research background and purpose to guide the analysis and document development. The analysis progresses as follows: ‘Why a BRT Synopsis’ (Part 1. Purpose), ‘Which BRT Projects’ (Part 1, Overview), ‘How Each Project Performed’ (Part 2. Case Studies), and ‘Key Takeaways for Future BRT Projects’ (Part 3. BRT Design Considerations), as illustrated in the figure below:

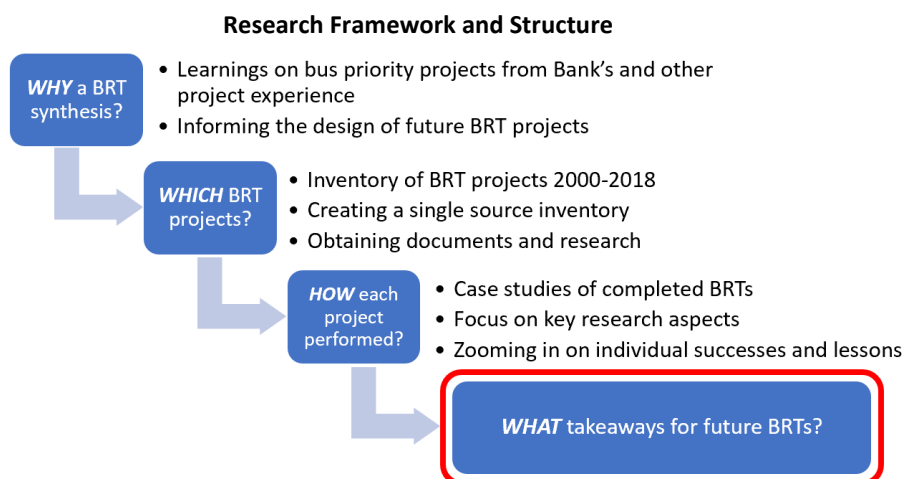

Source: Authors

Part 1 elaborates on the ‘which’ and ‘why’ of the research framework. It creates an inventory of World Bank-financed BRT projects from 2000 through to September 2018 and captures key features related to financing, implementation timeframe, performance, and monitoring and evaluation.

Part 2 zooms in on the ‘how’ by analyzing each project’s implementation experience, performance, and strengths and weaknesses. Based on the review of the project documents and other complementary secondary sources, each city’s case study starts with the project background and a macrolevel assessment of its outcome, followed by details of specific aspects of institutional frameworks, BRT design and operations, private sector engagement, and other features unique to each project. Finally, each case study highlights key lessons learned.

Part 3 synthesizes the global learnings from Part 2 and delves into the ‘what,’ which refers to the key takeaways and practical considerations for developing BRT projects. This section also draws on some of the lessons discussed at the World Bank’s Urban Mobility Global Group (UMGSG) BRT learning event (2019) which reviewed technical, financial and institutional approaches to sector reform as well as issues associated with

project-affected populations; public transport beneficiaries; and incumbent bus/paratransit operators.

Part 3 is organized into three sections: 1) practical insights into BRT applications; 2) ‘software’ elements of BRT, such as institutions, operations management, financial sustainability; and 3) the ‘hardware’ such as infrastructure and operations design of BRT. Each section is preceded by a summary of key points pertaining to the discussion.

Inventory and Overview of the Completed BRT Projects

Inventory of the Completed Projects. For the period from 2000 through 2018, the World Bank financed a total of 19 BRT systems under Investment Project Financing (IPF), including nine completed BRT projects by the end of 2018, the time this research project began, and 10 in various stages of implementation.

Among the projects under implementation, the Buenos Aires Matanzas BRT was operational by 2017 but not completed until December 2019. Since the project completion evaluation is pending, this report references the project but does not include it in Part 2’s case studies.

Locations of Completed BRT Projects under Bank-Financing (2000-2018)

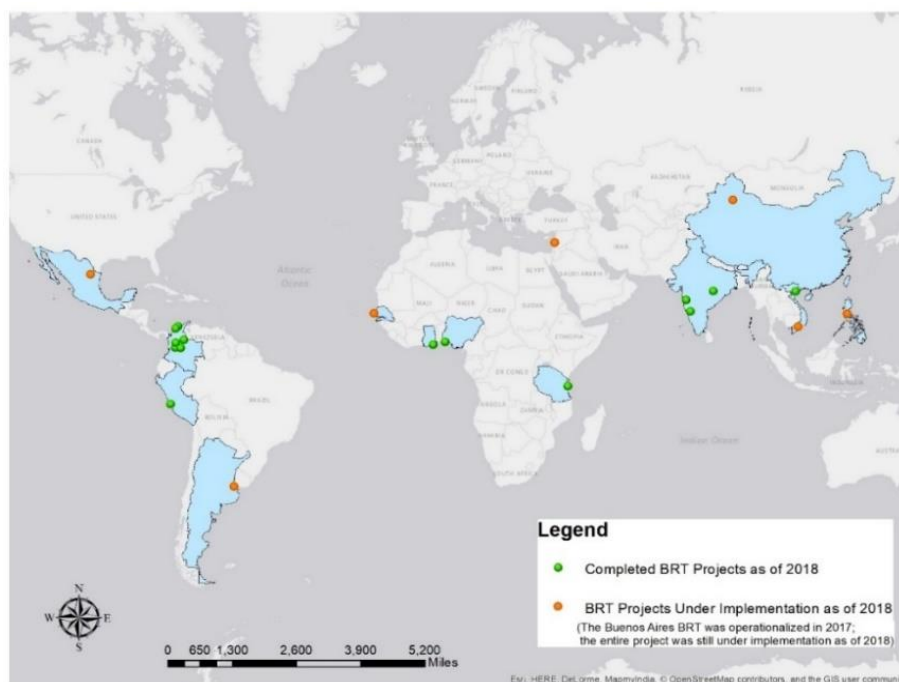

Source: Authors based on World Bank Data

The report then proceeds with detailed evaluations of the nine completed BRT projects as of 2018, based on a full spectrum of documentation including the Implementation Completion Results Reports (ICR). These projects represent a total cost of \$4.1 billion,¹ of which \$1.7 billion was financed by the World Bank.

¹All values used in this report are converted to current U.S. dollars. Due to the wide range of data over two decades, this report extracts and estimates value in U.S. dollars as is from reported documents and does not convert values to the current year.

The case study projects are located in seven countries involving 14 cities: Accra in Ghana, Bogotá in Colombia (two projects), six cities in Colombia (Bogotá, Barranquilla, Bucaramanga, Cartagena, Pereira, and Medellín), Dar es Salaam in Tanzania, Hanoi in Vietnam, three mid-sized cities in India (Hubli-Dharwad, Naya Raipur, and Pimpri-Chinchwad), Lagos in Nigeria, and Lima in Peru. The completion years are shown below.

Completion Years of the Nine BRT Projects (as of September 2018)

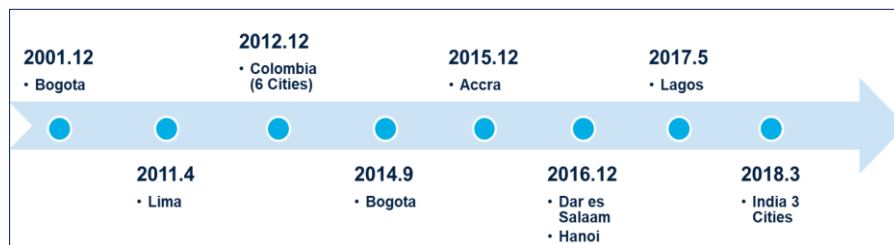

Note: Urban transport projects often have other non-BRT activities. The year of completion used here is based on the completion of the entire project, not only the BRT component.

Length of Project Implementation. Implementing BRT corridors in complex urban environments is a challenging undertaking due to the lack of utility location information and even land records. Among the nine case study projects, eight encountered delays that extended the project completion date and led to internal World Bank project restructuring during the course of the project term. Contributory factors included utility relocation and land acquisition, changing local circumstances over multiyear implementations, adverse political environments, schedule delays and cost overruns, and unforeseen risks sometimes beyond a city’s control.

BRT planners and engineers need to recognize this complex reality and exercise flexibility and adaptability to cope with ‘on-the-ground’ events as they occur.

Length for Entire Project Implementation (Actual vs. Original Plan)

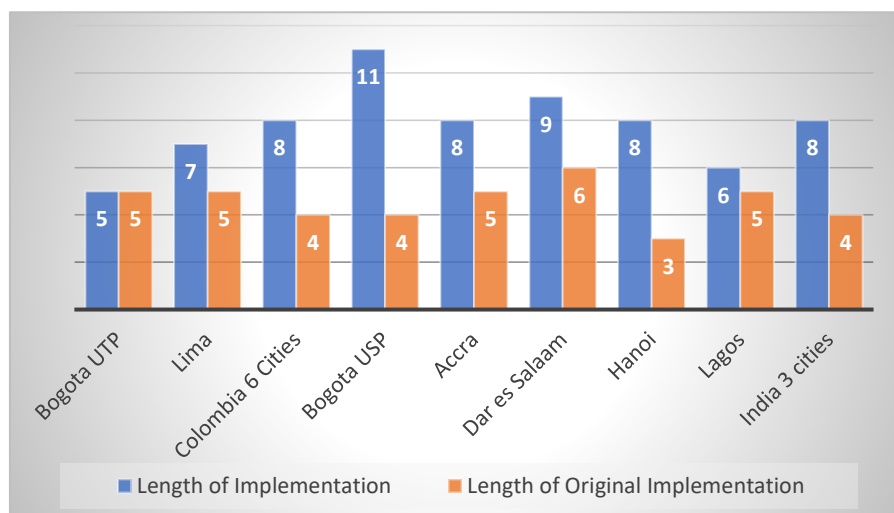

Note: Urban transport projects often have other non-BRT activities. The year of completion used here is based on the completion of the entire project, not only the BRT component.

Highlights of BRTs in Case Study Cities

All completed BRT projects had similar Project Development Objectives (PDO) that focused on improving transport and mobility and encouraging modal shift to environmentally sustainable public transport. In some cases, PDOs included a specific aim to deliver systems that are reliable and cost-effective (Dar es Salaam). Other common objectives included improving access for the poor and strengthening institutional capacity, with one case targeting improvements in local level urban transport planning and traffic management (Accra, NUTP Colombia). A few projects highlighted developing integrated urban transport plans and policies to enhance economic productivity and quality of life (Colombia's NUTP cities, Lima, Lagos).

The PDOs have been largely achieved in the case study cities, with significant mode shift from private vehicles to BRT and improving mobility. However, lack of integration caused access issues for some cities, and while BRT offered some access benefits to the poor, results have been mixed.² Lagos, Hanoi, and mid-sized cities in India saw significant mode shifts, with Lagos in particular attracting users who did not typically use public transport. All cities improved mobility. Some projects lacked integration with feeder buses early on, which affected travel costs.

Capacity development has proven instrumental in delivering successful projects. All projects generally acted to strengthen institutions in charge of planning and managing transport. An early emphasis on capacity and skills development delivered significant success, particularly in developing local mobility initiatives and design approaches and by empowering project implementers to deal competently with unforeseen risks (India and Lagos).

BRT became a catalyst for institutional and sector reform in some cases. The establishment of Urban Transport Authorities (UTA) specifically to lead BRT implementation was less effective. Planned UTAs in some cases were not realized (Hanoi, India cities³); some were not sufficiently robust as a political, regulatory or coordinating entity to undertake implementation of a major sector reform together with a BRT implementation (Accra); and some new BRT agencies lacked the strength to match influential power players (Dar es Salaam). In the case of Colombian cities, a central government program provided technical assistance and funding while municipalities formulated projects. In the Indian cities, establishing financial and technical resources at the state level developed a centralized capacity that was able to effectively support multiple cities in their state.

Key highlights of the case study cities in implementing BRT are briefly described as follows (in alphabetic order) and fully detailed in Part 2:

² Some cities performed better than others largely due to better connections offered by feeder buses, implementation of fare integration, and consideration of affordability issues.

³ The establishment of Unified Metropolitan Transport Authorities (UMTA) is included under in the National Urban Transport Management Policy and alluded to in the Project Appraisal Document (PAD 2009) for the Sustainable Urban Transport Project (SUTP) project in Indian cities under the category of key urban transport reforms. However, the PAD does not appear to directly commit to establishing UMTA as a key project objective.

Accra BRT

The project did not implement the BRT due to cost overruns, opting instead for a Quality Bus System (QBS). A remarkable achievement was the institutional reform, in establishing Greater Accra Passenger Transport Executive (GAPTE) as the regulatory authority, and through a consultative process the engagement of the dominant informal sector into a formal licensing scheme that will improve standards and provide business opportunity.

The high number of actors in the urban transport sector and the lack of clear ownership presented challenges, and GAPTE was not sufficiently robust as a political, regulating or coordinating entity to undertake major sector reforms as well as a BRT build.

The QBS struggles with traffic congestion due to lack of dedicated lanes, which created financial hardships, but QBS provides valuable experience upon which to build ongoing improvements.

Formalizing the route operators is a significant step to improving regulation and standardization of services since it establishes the government's role as facilitator /regulator of public transport in contrast to previous self-regulation of the tro sector⁴.

Bogotá BRT (over three phases including one project under NUTP)

Bogotá's TransMilenio project was developed with solid planning objectives that included a socially inclusive approach to transforming city mobility. It introduced TransMilenio SA as the network manager and built a regulatory model of private sector operators while also including existing stakeholders into the new business model. All three BRT projects in Bogotá achieved their PDOs with remarkable system performance.

However, TransMilenio's earlier mandate for full cost recovery from fares of its operational expenditure proved difficult to manage, causing pressure on fares and user dissatisfaction with particular impacts on the affordability for low-income users. The quest for full cost recovery through higher efficiency and productivity manifested itself in passenger overcrowding, which negatively impacted public support. Since 2015, legislative changes involved replacing 'financial self-sufficiency' with 'financial sustainability,' allowing other funding sources to supplement fare revenue.

Given high levels of demand, the system faces ongoing challenges of overcrowding and route complexity. Long-term solutions as well as immediate steps are needed to improve service quality. Although they involved serious challenges, Phases 2 and 3 successfully expanded the formal public transport network and reformed the city's bus system.

⁴ Tro tro refer to privately owned minibus share taxis that travel fixed routes leaving when filled to capacity. While there are tro stations, these vehicles can also be boarded anywhere along the route.

Colombian BRT Program – Six cities (Bogotá⁵, Barranquilla, Bucaramanga, Cartagena, Medellín and Pereira)

Colombia's decision to scale up the successful Bogotá's BRT under the National Urban Transport Scheme (NUTP) provided political emphasis, and offered technical assistance and a proportion of the funding required for cities to undertake their own BRT projects.

In each case, a key intervention was to define a new regulatory framework to address operational problems and negative impacts of traditional bus transport. Lower than expected ridership in all cities caused financial hardship, but cities with greater success improved BRT integration with the surrounding networks and feeder services. Despite the varying levels of challenges and successes, BRT served as a catalyst for cities to develop their own integrated road-based public transport systems. While access to the poor remains a challenge, the percentage of low-income passengers using BRT increased significantly, reaching 71 percent on Barranquilla BRT and around 60 percent on Pereira and Bucaramanga BRTs.

Dar es Salaam BRT

Following the style of Latin American models, Dar es Salaam built a high-quality system that inspired other sub-Saharan Africa (SSA) cities looking for ways to transform urban mobility. Dar es Salaam's Line 1 has been operating for over three years, and further expansion is underway. At opening, the BRT carried 180,000 daily passengers and reduced travel time along the corridor by a remarkable 50 percent.

However, in planning, idealism trounced pragmatism, meaning that on-the-ground realities were not sufficiently understood or considered. This caused ongoing repercussions in operational performance and contractual arrangements. Lack of institutional readiness, uncertainty surrounding the business model and risk assignment, and an unclear plan on how to incorporate the displaced daladala minibus sector⁶ posed difficult implementation challenges.

Hanoi BRT

Hanoi's BRT experience presents valuable lessons on the complexity of implementing BRT. Despite its challenges, the case provides an example of a pilot BRT system that is replicable in other corridors. The project also instilled into city managers the confidence in their ability to improve public transport.

While other PDOs were met, ridership fell well below the target with 14,000 daily at opening, partly reflecting the limited integration with regular bus services. Over 50 percent of surveyed users report being previous motorcycle riders.

The lack of a **definitive operational plan** and feasibility study at the commencement of the project caused uncertainty and an underlying lack of confidence. However, local pragmatic solutions were devised to meet challenges, and the city now has a system upon which it can expand. Improved integration with the general bus network and more consistent enforcement of bus priority is needed, but these are not

⁵ Bogota was included in the Bogota case study, which is separate from the case studies of other Colombian cities.

⁶ Daladala is the informal (semi-regulated) mini-buses that ply in Dar es Salaam

insurmountable challenges. The system's successful future will require ongoing commitment by Hanoi's leadership, to include an active strategy to incentivize change in passengers' mobility choices.

India BRT Program-Three mid-sized cities (Hubli-Dharwad, Naya Raipur and Pimpri-Chinchwad):

India's three-city BRT project was remarkable in that it prioritized capacity building as a first intervention, which equipped local decisionmakers to define their own mobility initiatives around the BRT implementation and develop competency to manage unforeseen risks.

This Global Environment Facility (GEF)-Sustainable Urban Transport Project (SUTP) involved a large capacity-building program in mid-sized cities where resources and capacity lag behind large cities. It utilized capacity at a state level to provide technical assistance to multiple cities. The BRT implementation programs overcame a myriad of challenges, notably land acquisition and contestations over street space. At opening, the cities achieved significant mode shift to public transport on BRT corridors. Ridership in Hubli-Dharwad rose to 100,000 daily, however in Pimpri-Chinchwad and Naya Raipur BRTs are lagging in ridership growth.

Hubli-Dharwad has had greater success arguably because it is the only city in the project that established a dedicated agency to manage the BRT, which became the clear owner of the project. The others handed over operations to the bus operators, resulting in ownership being less defined (the city or bus operator?), affecting decision making and system performance.

BRT in Dar es Salaam and Hubli-Dharwad



Dar es Salaam, Tanzania



Hubli-Dharwad, India

Source: Yonas Mchomvu, Nupur Gupta, World Bank

Lagos BRT

The Lagos BRT demonstrated that a BRT project does not necessarily need to achieve 'full BRT' status, instead it can use a variety of bus system improvements appropriate to the local context. Lagos Phase 1 BRT commenced with a government-sponsored BRT Lite project supported by Bank funded technical assistance. The project took a pragmatic design approach by concentrating infrastructure on where it delivered the most impact. Building on BRT Lite's success, the Bank financed Phase 2 (LUTP2), which involved system improvements and median BRT extension and road widening. System performance has been remarkable for a low-cost BRT, with daily ridership reaching 200,000 passengers.

This pragmatic approach involved strategically prioritized actions, such as comprehensive public engagement and communications to build public acceptance and trust, and design/build construction contracts to reduce delays.

Also notable was the early and comprehensive investment in capacity building in all aspects of transport management, which was instrumental to success. Integrated Public Transport System (the transport authority in Lagos, also known as LAMATA) has become a textbook example of how to develop institutional strengthening, fostering a competency to undertake a locally-derived system design and in managing unforeseen risks. The crisis of deteriorating performance of the first BRT operating company for BRT Lite demonstrates how the business model can influence behavior. In this case, the operator seized control over revenue to gain a power advantage to exploit a financial opportunity. Fortunately, LAMATA was able to prevail and terminated the contract.

Lima BRT

Lima leveraged outstanding political support to develop a BRT system out of a chaotic transport situation. Ridership took time to build up, causing some early difficulties. However, once the system was fully operational, it exceeded its target demands and achieved its PDOs, including reductions in travel time by 34 percent, and in fatal and serious accidents by 65 percent.

Despite a key objective to improve access to the poor, the project found this a challenging task, and Protransporte is now aiming to improve access and affordability by implementing a large feeder route network and also optimizing its fare policies.

Fleet renewal and bus scrapping were part of the reforms but they added an extra layer of complexity that caused delays. Separating fleet renewal from the critical path of the project was a lesson to be learned.

Practical Insights into BRT Applications

This section looks at perceptions of what BRT is by drawing on experiences from case studies and research. It aims to provoke deeper thought on applications of BRT in the local context. BRT design needs to consider the unique characteristics of each city, such as social norms, demographics and varying transportation conditions and needs. Attention is drawn to three key features, being that BRT can represent an integrated set of measures, being realistic on BRT capacity, and having an understanding of the political dimension. As follows:

While BRT offers a range of design options for both infrastructure and operations and is an effective instrument in the Urban Mobility Toolbox, it is not a 'silver bullet' solution for every city and corridor. BRT should be approached as an integrated set of measures that can be applied according to the local conditions. Characteristically, BRT aims at improving the standard of road-based public transport with quality infrastructure and high-frequency services to promote substantial ridership. The case studies consistently demonstrated BRT to be a key intervention and cost-effective instrument to address the urban mobility conundrum that cities face.

In its basic form, BRT infrastructure can range from low-cost infrastructure ('lite') that offers operational enhancements (sometimes with lower capacity), to more

sophisticated high capacity infrastructure. This should not be regarded as an either/or choice, as BRT design can blend various features to satisfy the agreed objectives developed in conjunction with city managers. It is also flexible, being able to adapt to the complex local systems in which cities operate, such as by balancing intricate interplays with other road-based transport modes and users, institutional structures, technology applications, and the prevailing political dimensions.

Corridors with lower demand or medium-sized cities⁷ can explore Integrated Corridor Management (ICM) that seamlessly combines bus lanes and other bus improvements with traffic management, road safety features, and walking and biking facilities as a cost-efficient alternative.

Urban Mobility Toolbox Showing the Range of Integrated Measures

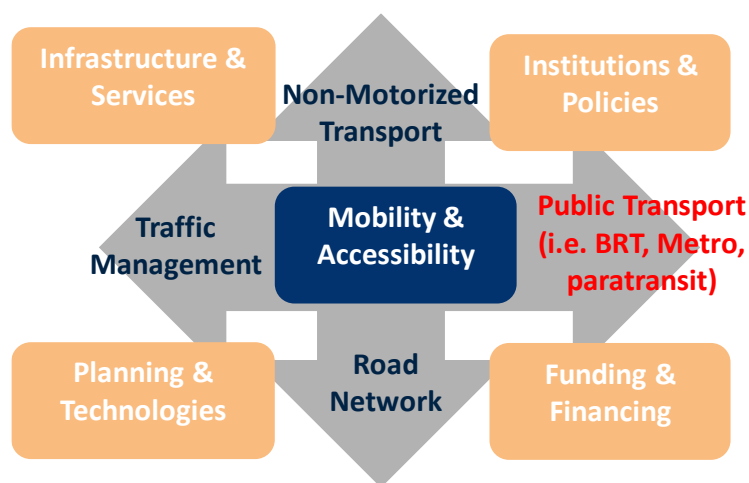

Source: UMGSG, World Bank, 2019

Regarding BRT corridor carrying capacity, this review found that globally, in typical cities, BRT systems have a corridor capacity threshold of around 10,000 passengers per hour per direction (phpd)⁸ before operational bottlenecks (such as berths at stations, intersections) begin to impact on efficiency and quality. There are notable exceptions, such as Bogotá and Guangzhou⁹, but these are outliers whose systems exhibit a much higher level of infrastructure that many cities will not be able to afford or achieve as they do not have the available road space to accommodate such infrastructure.

Choice of rapid transit options should be based on needs and not on technology. A proper alternative analysis with logical sequence is required to transparently and objectively compare benefits and costs.

The political dimension also must be well understood, hence the emphasis on a political champion to drive the project – but local ownership of the project is equally important.

⁷ Medium-sized cities generally denotes cities with <0.5M to 3.5M population, although in India it would be cities with less than 10M population.

⁸ Velásquez JM, Th Tun TH, Hidalgo D Ramos C, Guarda P, Guo Z, and Chen X. (2017) Bus Rapid Transit in China: A Comparison of Design Features with International Systems. https://www.wri.org/sites/default/files/bus-rapid-transit-in-china_1.pdf Last accessed March 31, 2019.

⁹ Guangzhou China established a BRT in 2010 moving more than 27,000 passengers per hour in a single direction and with more than 800,000 boardings per day,

In this respect, local decisionmakers should be fully conversant with the ‘why, what and how’ to guide the decision-making process. Having agreed objectives is a crucial early step to rally political support and commitment. These objectives should be clear and defined (and measurable if possible), being a statement of what the project is designed to achieve. Lagos offers a good example of a design with clear objectives but flexibility to meet identified targets, such as travel time, affordability and applicability to the local environment. Developing a Strategic Planning Framework will generate greater local buy-in and ownership, ensure commitment and support during project implementation, and inform BRT design.

The Software of BRT - Institutions, Operations Management, Financial Sustainability

The institutional aspects of BRT can have more influence than infrastructure on the BRT’s success. Flawed design in BRT infrastructure can reduce a system’s effectiveness, but a weak or botched institutional framework could see the system fail.

Case study cities, where a mid-level agency is established to manage the business of the BRT (not just regulating it) and where they are the owner of the system, are more successful. Such an agency needs a well-defined and strong management role that enables it to exercise control and authority over the system, and be a capable partner in managing bus operator contracts.

Projects have sometimes mandated establishment of an Urban Transport Authority (UTA) to improve coordination and lead BRT implementation, but a newly established entity is unlikely to be equipped to manage in parallel, major transport reforms and a large BRT infrastructure project. In some case cities, the UTA was not realized. Experience suggests that in a low-capacity environment, *it might be better to harness or facilitate existing coordinating mechanisms to implement BRT*.

The role and function of the authority/agency need clear definitions, whether it is to serve at a high level and be responsible mainly for policy, planning, and regulation (LAMATA Lagos), or at a middle level, in managing BRT day-to-day operations, service planning, and the operator contracts (TransMilenio-Bogotá, Protransporte-Lima).

The following figure outlines a shared-risk tiered approach, assigning the separate responsibilities and risks for strategic policy, business management and operations.

Tiered Level of Functions and Risk Assignments Among Players

STRATEGIC PLANNING and COORDINATION - Takes Political Risk

**High Level Coordination
The Transport Authority**

- Sets strategic policy. *What level of service does the city wish to provide?*
- Manages the **political agenda** and resolves political issues
- Develops the **Strategic Service Plan** (business plan for bus system manager)

BUSINESS MANAGEMENT AND TACTICAL PLANNING - Takes Business Risk

**Middle Level
The System Manager
Manages the Network
Operates the Business**

- Grow patronage and revenue
- Responsible for customer service delivery
- Ensure financial performance
- Fare collection and ticketing
- Plan routes, control and monitor service delivery
- Manage and enforce bus operator contracts
- Community relations/marketing and promotion

PROVIDING SERVICES - Takes Operational Risk

Bus Operating Companies

- Provide bus services under quality contract to provide set level of service

Source: Frits Olyslagers

Management capacity of the agency needs to be robust, with careful attention given to the relationship (or power balance) with operators. In particular, this relates to the contractual assignment of roles, responsibilities and risks between the BRT agency and operators, defining the power relationship and influencing the behavior of the players, as experienced in Dar es Salaam and Lagos BRT Lite.

The bus operator contract is not a standard model contract; it needs to be tailored to local context and to the relative strengths of the parties. Typically, bus operator contracts are classified as net-cost contracts (NCC) where the operator carries the financial risk, and gross-cost contracts (GCC) which places revenue risk on the agency (city). Hybrid contract models where risk is shared are becoming more common. Due to risk exposure on both sides, it is useful to think of a hybrid contract as a partnership contract. The following figure outlines the type of contract appropriate to different circumstances, namely the experience of the operators and their ability to manage risk.

Hybrid Contracts Based on Relative Capacity of the Parties



Requires More Agency Control	Allows Some Operator Control	
Suits less experienced operators	↔	Suits more experienced operator
Protected from demand risk	↔	Able to take some demand risk
Service planning wholly by the agency	↔	Operator involved in service planning
Prescriptive service specifications	↔	Greater flexibility to innovate and develop service efficiency
Paid set rate for supply of services (but could include passenger incentive)	↔	Paid for services but business model rewards ridership growth
Strong emphasis on penalty regime to guarantee quality	↔	More emphasis on economic incentives for quality service delivery (+some penalties)

Source: Frits Olyslagers

Procurement of operators for new contracting arrangements is a major challenge. Cities may choose competitive tendering to select a new operator, or otherwise negotiate contracts with incumbent operators. This requires a careful approach so that a competitive and realistic price is secured, and financial sustainability not compromised. Typically, operators are unfamiliar with new arrangements and/or lack trust in government, or they may have practical concerns over issues such as loss of employment. However, when a new contract identifies costs and appropriately assigns risks, it is likely to be a more sustainable business model than what operators currently have, so the city should not be hesitant to promote a transition to a new business opportunity. The figure on the next page shows important areas to consider and the subsequent steps involved in the process.

Section 15.2 of the main document outlines a range of options in managing this procurement, from fostering change (inclusion of incumbent operators) to forcing change through a competitive bidding process. It recommends that a city takes an active facilitation role and lists a number of enablers to assist the process. Fostering effective communications with interested groups, addressing their concerns and securing their support can create a positive force field around the project, which can significantly help to overcome implementation challenges.

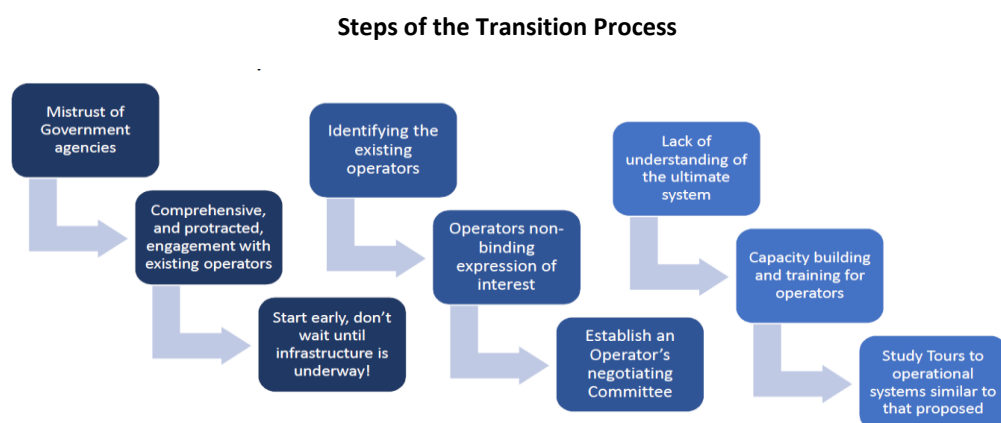

Source: UMGSG, World Bank, 2019

BRT can be leveraged to spearhead wider reforms to formalize the passenger transport sector and rationalize operators and services. A large government investment in transport infrastructure can create momentum for change, but in turn, reforms are often necessary to support BRT implementation. However, caution is required since there are complex and diverse issues to consider, such as political conditions, powerful vested interests, industry capacity to manage and adapt to change, current fleet supply, technical capacity and the ability to enforce standards.

A consistent and parallel effort is required to adapt the industry to the new model of public transport. This should occur prior to, or early in the implementation of a BRT program. An example is Dakar, Senegal, which initiated sector reform independent of BRT, through a fleet renewal program, which catalyzed the formalizing of bus operations and equipping the sector to participate in the BRT development.

Leveraging BRT for sector reform should aim for a “triple win” – benefits for the city, for the customer and for the operator. Simply using BRT leverage to enact sector reform, without a clear-eyed view of local conditions, could run into serious problems.

Paratransit operators, while often displaced by BRT, are an essential part of the network supporting BRT¹⁰. Paratransit ownership structures are not always identifiable, and their semi legal/vulnerable status often fosters political affiliations. Lack of capacity may also hinder participation by informal paratransit operators. Notwithstanding the challenges, a good approach is to focus on business transition that empowers the industry either by (1) incorporating interested parties into a formal entity to operate the BRT as a service provider company or (2) structuring operators into a business model that provides feeder services to the BRT, which can be an effective approach since it leverages their ability to fill the gaps as feeders to the BRT and to provide complementary services in lower-demand corridors and peri-urban areas.

With BRT and public transport generally, cities need to balance financial sustainability with transport affordability and wider social objectives by fine-tuning fare policy, subsidy levels and operational efficiency. Where fare setting is a political exercise, resulting in financial deficits, stable alternative sources of funding will need to be secured.

However, while subsidy or non-fare revenue is usually required, such funding should not be considered automatic compensation for financial losses. The use of subsidy funding must be a commercial decision based on well-grounded financial and economic analysis and structured in a way that avoids fostering subsidy dependency, which may dilute management’s focus on business performance. Furthermore, fare policy (willingness-to-pay and affordability) must be managed, together with a strategy to achieve ridership targets.

From a business management perspective, financial sustainability requires establishing the business case and taking a business-like (commercial) approach to develop the market, build ridership and revenues, and efficiently managing costs.

The Hardware of BRT: Infrastructure and Operational Design

Complex environments make BRT design inherently difficult given competing objectives and many interfaces to manage. Section 16 offers a limited set of priority learnings that stood out during the authors’ review of case studies and research; it is not intended to cover all the diverse design elements of a BRT.

¹⁰ Paratransit Operators refer to semi-formal transport providers who have often proliferated where formal transport systems are lacking. They can comprise a range of vehicle types, such as mini-buses, jeepneys, and three-wheelers etc.

Illustration of BRT 'Hardware'

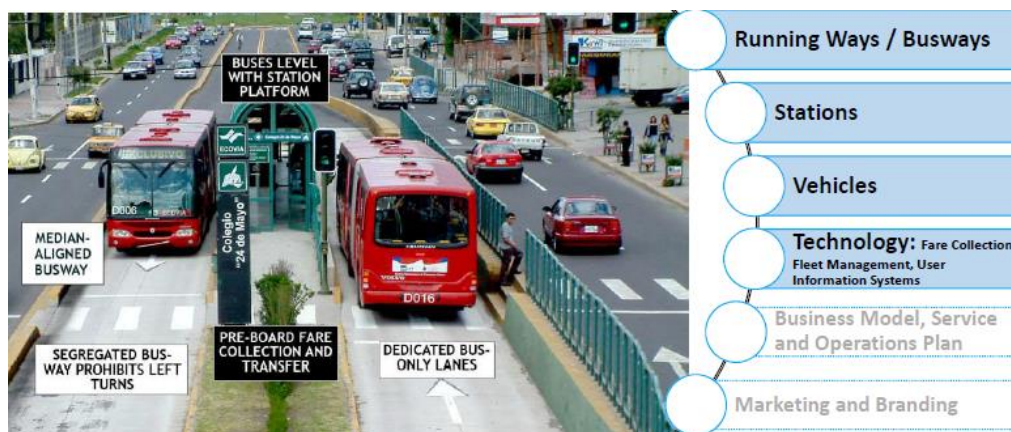

Source: UMGSG, World Bank, 2019

The decision to proceed with BRT development should be the result of a sound planning and alternatives analysis exercise. It should not be 'technology-driven' but take a needs-based approach to guide the selection of specific technology.

The physical and operational integration of BRT as part of a public transport network is difficult to manage in part due to the unique and complex urban environments in which BRTs are built, and it usually require some trade-offs. For example, where BRT operations are disconnected from local bus services, the gain in travel time savings on the BRT could be lost in passenger transfer and access time.

Operations planning and infrastructure design are interdependent processes. Operations planning is a core part of the *Concept and Feasibility Plan* upon which the city gives approval, thus allowing the project to proceed to detailed design. BRT operations planning should guide the infrastructure design and not be left until it is time to operationalize the system. *It is good practice to establish design principles at the start of a project*, aligning them with the agreed objectives set by the city, and then to conduct operations planning *as an iterative and convergent process*. Such an approach - where the city is involved in all aspects of planning, will develop a greater sense of ownership, improve their confidence in the project, and assist in the making of timely and supportive decisions.

BRT design should be adapted to local context and conditions and should not rely on prescriptive design standards. Adaptation to local conditions is often branded as a design compromise and frequently blamed on political expediency. However, BRT is inherently a political exercise, and in this regard, the flexibility of BRT provides a particular advantage since it allows planners to innovate and adjust plans, genuinely respond to feedback from stakeholders, and even to adjust to political reality. Care should be taken in using the *BRT Standard Scoring System*¹¹ as it may result in a prescriptive design approach that does not align well with the local conditions. For example, the decision to go with painted curbside bus lanes over segregated busways is not to be ranked or scored, but rather a choice made through thoughtful analysis and

¹¹ The BRT Scoring system as developed by ITDP.

debate. As shown in the Lagos case, success does not rely on meeting arbitrary or prescriptive standards but on being able to efficiently meet the needs and objectives that the city had identified at the outset.

BRT Blended with the Local Conditions and Urban Fabric (Buenos Aires)



Source: Camila Rodriguez, World Bank

Common design choices as seen in the case study cities have shown that:

In selecting the first corridor, a good approach is to aim for *maximum benefit with manageable effort* by selecting an important corridor which is 'doable' and can serve as a proof-of-concept pilot. In choosing the initial corridor, cities sometimes select corridors that suffer low ridership or opt for the densest corridor, which may prove to have a much greater implementation (political) risk. Cities must consider all critical aspects, from implementation issues, early impacts and long-term sustainability.

The decision for curbside or median alignment is not a binary choice as systems can use both types within the one system if necessary. Curbside alignment may be suitable where roads are narrower and allows the station/bus stop facilities to be incorporated on the sidewalk, reducing the demand on road space, whereas median alignment is less subject to operations disruptions and encroachment and capable of providing higher bus throughput and frequency.

A direct BRT system (off/on busway) improves integration by reducing passenger transfers, penetrating communities, and improves 'first-last-mile' access. Direct services are more suited to corridors of medium density and moderate ridership.

However, a closed BRT system is more suited to higher capacity systems, avoiding the random entry of buses onto the busway which could disrupt a highly scheduled BRT trunk operation. It also allows for better allocation and utilization of resources by concentrating high capacity vehicles on the trunk route where high demand exists and allows feeder services to be tailored to demand, using smaller buses. Passengers understand the simple design concept of a trunk-feeder system, where route design is less complex.

Illustration of Closed and Open System Design

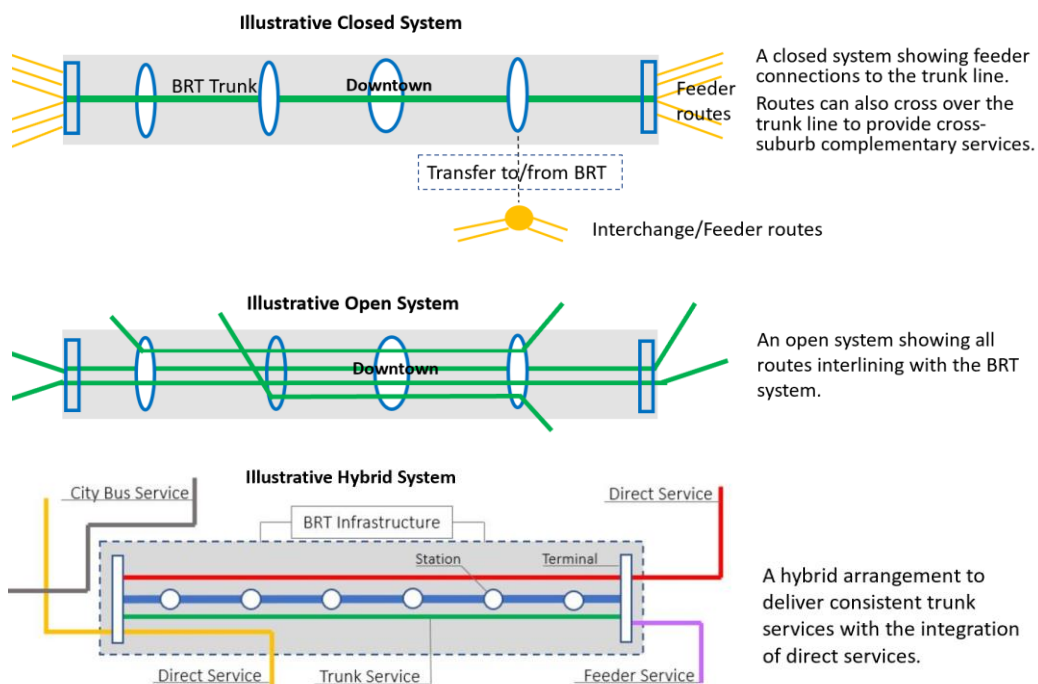

Source: Wenyu Jia, Elkin Bello, World Bank

Intersection control is often not sufficiently prioritized in BRT design, but it plays an essential role in maintaining reliable schedules and helps to space buses properly to avoid overloading stations - a key capacity constraint.

Station designs must consider passenger capacity requirements, including convenience, safety, wayfinding, pedestrian flow, and passengers with special needs. ROW constraints at stations may require some innovative planning which could include the use of guided bus systems to improve bus docking and reduce space demand.

In medium-sized cities, BRT implementation faces some unique challenges that require different approaches and innovations to manage lower demand and/or address institutional weakness and financial affordability issues. The first step is appreciating the challenges and working to develop capacity, and then designing BRT according to the city's scale and affordability. Since these projects are relatively smaller, the prospects of better integrating BRT could be explored. For corridors with lower demand or in medium-sized cities, Integrated Corridor Management (ICM) can be a cost-efficient alternative to addressing current public transport needs while setting the stage for future mass transit interventions when conditions are ready.

This page intentionally left blank

Part 1. Overview of Bank-Financed BRT Projects

This page intentionally left blank

1. Purpose and Use of the Document

1.1. Objectives

This document serves as an inventory and synopsis of the completed Bank-funded Bus Rapid Transit (BRT) projects from 2000 through 2018 (time of this research). It documents findings related to select aspects discussed in the case study cities and extracts the experiences, challenges, successes and lessons learned. In so doing, the document relays practical, ground-level guidance on BRT planning and implementation to enrich the global body of knowledge related to BRT development and implementation. The target audience includes the World Bank's transport practitioners, client cities, partners, and stakeholders.

1.2. Background

The World Bank's support for BRT initiatives has been extensive over the past two decades, involving institutional and regulatory reforms, public transport and network planning, alternatives analyses, corridor design, and bus operations. Synthesizing this experience from ground-level engagements and knowledge helps to extract learnings for new projects under conceptualization.

Cities planning BRT frequently undertake study tours to cities with BRT experience to gain first-hand knowledge of design, construction and operations. Although such tours can be insightful, they are resource intensive. This synopsis could serve as a resource to highlight key issues in BRT planning and implementation, and to guide the Bank's clients in selecting a BRT tour that resembles the context of their own cities, with a clearer focus on issues of interest.

1.3. Use of the Document

This document, primarily based on a desktop research of internal documents and external research, provides a broad-brush overview of successes and lessons pertaining to the BRT projects in case study cities. Where research is available, the study went deeper than the Bank's Project Implementation Completion Results Reports (ICRs) on the selected key research aspects. However, it is not intended to be a 'deep dive' as there are a myriad of complex factors impacting on each city's project design and implementation that is beyond the grasp of a desktop research effort.

This document in all respects aims to conduct an honest and balanced appraisal of BRT experiences to understand the underlying reasons and causes for results. In doing so, potentially optimistic or critical views may be apparent, and they only represent the views of the authors. The review team fully understands that most BRT systems operate within a tangled web of politics, economic constraints, a steep learning curve, and extensive coordination, where innovation is being tested.

Finally, the document applauds the efforts of cities across the globe to innovate and transform urban mobility, and salutes the decision-makers and practitioners who support such projects, with untiring efforts and self-sacrifice.

2. Overarching Framework of the Research

BRT developments are complex as they involve political, institutional, infrastructural, operational and financial aspects among others, all of which intertwine with each other in the planning, implementation and operations phases. Building upon the research background and purpose, the authors developed a framework to guide the analysis and document development, as illustrated below.

Figure 1.2-1: Research Framework and Flow

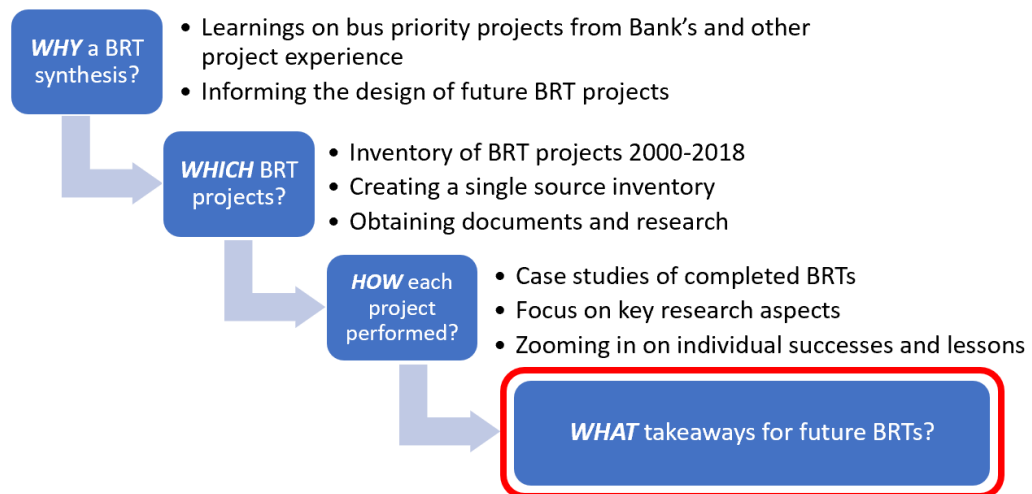

Source: Authors

The research focuses on the above key aspects by analyzing the BRT project case studies through a logical flow from Parts 1 to 3. The study also considers the diverging views on BRT projects. It addresses relevant successes and lessons by referring to evidence and facts pertaining to the case studies.

Part 1 elaborates on the 'which' and 'why' of the research framework. It provides an inventory of World Bank financed BRT system development projects from the year 2000 through 2018 through research, verification, and compilation of documents and available data. Based on the inventory, it captures key features related to financing components, implementation timeframe, and performance as related to monitoring and evaluation measures for all completed BRT development projects.

Part 2 zooms in on the 'how' by analyzing each project's implementation experience, performance, and strengths and weaknesses. Each case study provides an in-depth analysis of experiences that highlight strength and weakness. Identifying less successful experiences serves not to criticize but to constructively inform future BRT planning and implementation. As more cities take on BRT development, they can use these experiences to better understand the complexities involved and take steps to mitigate potential obstacles. The case studies start with a description of the project background and a macrolevel assessment of the outcome. They then detail the selected aspects of BRT design, operations maintenance, private sector engagement, and other features that may be unique to a specific project. This kind of analysis can illustrate areas of

performance where cities got it right or where they encountered difficulties or poor performance, or outcomes that did not meet expectations. Finally, each case study highlights key lessons learned.

Part 3 synthesizes the global learnings from Part 2 and delves into the ‘what,’ which refers to the key takeaways and practical considerations for developing BRT projects. This section draws on some of the lessons discussed at the World Bank’s Urban Mobility Global Group (UMGSG) BRT learning event (2019) which reviewed technical, financial and institutional approaches to sector reform as well as issues associated with project-affected populations; public transport beneficiaries; and incumbent bus/paratransit operators.

Part 3 is organized into three sections: 1) practical insights into BRT applications; 2) ‘software’ elements of BRT, such as institutions, operations management, financial sustainability; and 3) the ‘hardware’ such as busway and station design etc. and operations design of BRT.

This format allows readers to refer to the subject and topic of interest while also referring to specific city contexts to understand the issues that arose. The format aims to deliver practical considerations of the myriad of BRT design issues that cities are likely to face.

3. Limitations of the Document

By design, the scope of this research is primarily to conduct a desktop review of World Bank project documents as well as published analyses on the selected case studies, focusing on selected aspects of BRT. These projects were completed in different years, with some operational for over ten years and others that are newly opened.

To obtain the entire spectrum of project learnings would require a systematic analysis of operations data across the cities using data-driven and detailed ‘deep-dives’ for each city, alongside a comparative study, which is beyond the scope of a desktop review. The research also had no scope to conduct field visits or discussions with the agencies and entities in charge of the BRT financing, planning, and operations in the case study cities. Given this limit in scope, the research may not be able to have captured all the details pertaining to a dynamic and complex BRT. The team also acknowledges that some observations may be dated and not reflective of more recent developments.

4. City Inventory Selection and Summary

The project began compiling the inventory of Bank-financed BRT projects with two objectives: (1) documenting the inventory of Bank-financed BRT investment projects (Investment Project Financing) (IPF) for the first time, to serve as a reference for the Bank and client cities going forward; and (2) determining which projects would be analyzed and evaluated.

The inventory identified a total of 19 BRT IPF Projects for the years 2000 through 2018, including 10 closed BRT IPF projects and nine in various stages of implementation. The

project then proceeded with detailed evaluations of nine closed BRT IPFs to study the spectrum of learnings from project design to implementation to operations. These projects are listed below:

1. Accra: Ghana Urban Transport Project (GUTP)
2. Bogotá: Urban Transport Project (UTP, also known as Bogotá 2001)
3. Bogotá: Urban Services Project (USP, also known as Bogotá 2014)
4. Columbia Six Cities: Colombia Integrated Mass Transit Systems Project of the Colombia National Urban Transport Program (NUTP)
5. Dar es Salaam: Second Central Transport Corridor Project (CTCP2)
6. Hanoi: Hanoi Urban Transport Development Project (UTDP)
7. India Three Cities: Sustainable Urban Transport Project (SUTP)
8. Lagos: Nigeria Lagos Urban Transport Project 2 (LUTP2)
9. Lima: Peru - Lima Transport Project (LTP)

4.1. Inventory Approach

As the study focuses only on Bank-financed BRT projects, the World Bank's Operation Portal is the most reliable resource to identify such projects and collect project documents. The study referred to other internal and external research resources to complement the inventory and case studies for deeper analyses. A quality control process of inventory results was developed to ensure its accuracy and integrity.

The detailed methodological steps for inventory collection are described below:

- 1) The research identified a list of projects within the defined timeframe, from the year 2000 through September 2018. After a review of each IPF project, only projects with BRT system development in their components were recorded into an initial BRT list.
- 2) The initial BRT list was compared with a BRT projects list from the World Bank's Urban Mobility Global Solution Group (UMGSG), resulting in a combined list of BRT projects that was evaluated, validated and established.
- 3) The documented project components, issues and outcomes were then carefully examined and categorized. As needed, Bank's project team leaders (TTL) and Internal Completion Results Report (ICR) authors were contacted for fact checking and verification.

Based on the defined research methodology, the inventory resulted in 19 BRT IPF projects from the year 2000 to through September 2018. According to the project status for each project in the operation portal, these BRT IPF projects were divided into two categories: 'completed' and 'under implementation.'

The nine completed BRT IPF projects include those with completed constructions, BRT lines under operation (except for Ghana BRT IPF), and have completed project evaluation. Active BRT IPF projects are those that have been approved by a Board and were under implementation at the time of the completed research. All nine completed BRT IPF projects have a total cost of \$4.1 billion, of which \$1.7 billion was financed by the World Bank.

The other 10 ongoing BRT IPF projects have an estimated total cost of \$5.5 billion at approval, of which \$2.1 billion is financed by the World Bank and are located in 13 cities (refer to table 4.1-2). Among the projects under implementation, the Buenos Aires Matanzas BRT was operational by 2017; however, the entire project was completed in December 2019, and as project completion evaluation is pending, the report references the project but did not include it in Part 2's case studies.

Figure 4.1-1: Locations of Bank-Financed BRT Projects

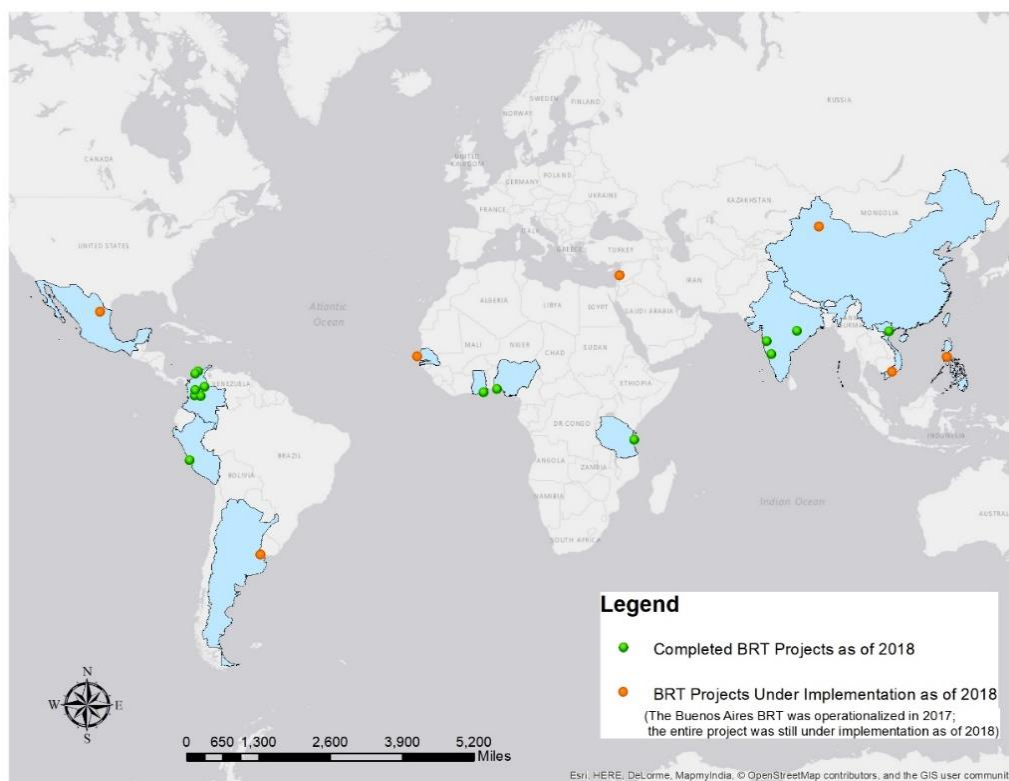

Source: Authors based on World Bank Data

The completed BRT IPF projects (including multiple cities in some projects) are mainly in Latin America (four projects in Colombia and one in Peru) and Africa (three projects being Ghana, Tanzania, and Nigeria). Apart from the seven projects in the above two regions, there is one completed project (Hanoi BRT project) in the East Asia and Pacific region, and one in India (the South Asia region). All nine projects are included in the case studies of Part 2.

Table 4.1-1: Completed BRT IPF Projects By Approval Date (as of September 2018)

Country	City	Approval Date	Closing Date	Years
Colombia	Bogotá	5/23/1996	12/31/2001	5
Peru	Lima	12/9/2003	4/30/2011	7
Colombia	Bogotá, Pereira, Barranquilla, Cartagena, Bucaramanga, Medellín	6/10/2004	12/31/2012	8
Colombia	Bogotá	3/13/2003	9/30/2014	11
Ghana	Accra	6/21/2007	12/15/2015	8
Vietnam	Hanoi	7/3/2007	12/31/2016	9
Tanzania	Dar es Salaam	5/27/2008	12/31/2016	8
India	Pimpri-Chinchwad, Hubli-Dharwad, Naya Raipur	12/10/2009	3/31/2018	8
Nigeria	Lagos	6/29/2010	5/31/2017	6

Note: Urban transport projects often have other non-BRT activities. The years of implementation used here is based the beginning and the completion of the entire project, not only the BRT component.

For the ongoing BRT projects, four projects are in East and Southeast Asia (China, Vietnam and Philippines), two in Africa, three in Latin America, one in South Asia, and one in the Middle East. These group of projects are not included in this review as implementation was ongoing by the time of this research initiation.

Table 4.1-2: Ongoing BRT IPF Projects by Approval Date (as of September 2018)

Country	City	Approval Date	Expected Closing Date	Years
Argentina	Buenos Aires	10/20/2009	12/31/2019	10
Mexico	Monterrey	3/25/2010	4/30/2019	9
Colombia	Bucaramanga, Cartagena, Medellín, Pereira	7/21/2011	9/30/2020	9
Vietnam	Ho Chi Minh City	5/29/2015	12/31/2020	5
Philippines	Cebu	9/26/2014	6/30/2021	6
China	Urumqi	12/21/2015	12/31/2021	6
Philippines	Manila	3/16/2017	11/30/2022	5
Senegal	Dakar	5/25/2017	6/30/2023	6
Tanzania	Dar es Salaam	3/8/2017	12/31/2023	6
Lebanon	Beirut	3/15/2018	12/31/2023	5

Note: Urban transport projects often have other non-BRT activities. The years of implementation used here are based the beginning and the completion of the entire project, not only the BRT component.

4.2. Introduction of World Bank's Investment Project Development and Financing

Investment Project Financing is one of the financing instruments of the World Bank. IPF focuses on the long term (a 5-10-year horizon) and supports a wide range of activities, including capital-intensive investments. IPF not only supplies borrowing countries with needed financing but also serves as a vehicle for sustained global knowledge transfer

and technical assistance. A World Bank-financed IPF project generally proceeds through a six-step cycle: Identification; Preparation; Appraisal; Negotiation/Approval; Implementation/Support; Completion/Evaluation.

Figure 4.2-1: IPF Project Cycle

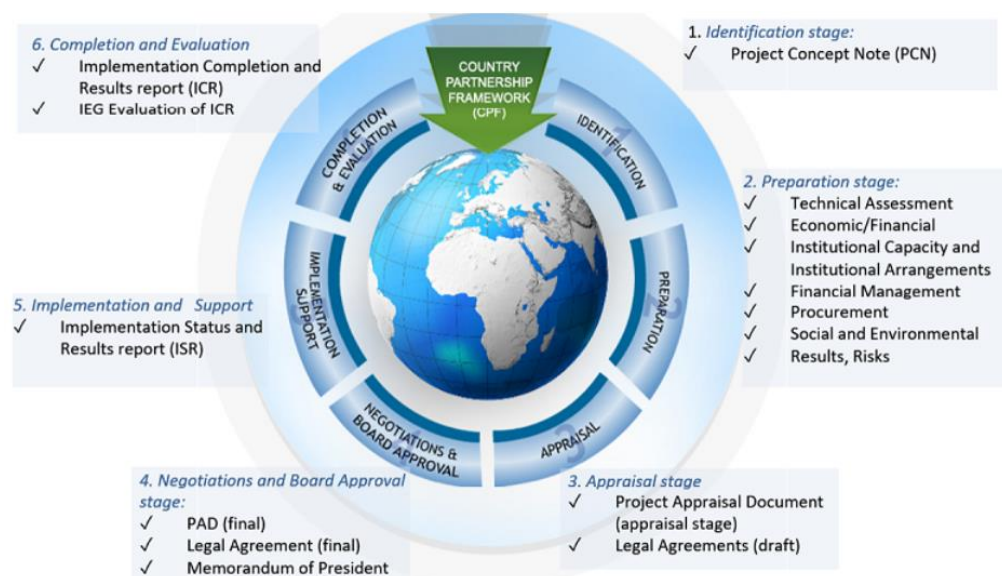

* Project Appraisal produces a Project Appraisal Document (PAD). All BRT projects, completed and under implementation, have PADs, which serve as one of the research sources.

** Project Completion and Evaluation produces an Implementation Completion Results Report (ICR). All completed BRT projects in this report have ICRs, which serve as one of the research sources.

Source: World Bank¹²

4.3. Financing of Completed BRT IPFs

The Bank-financed BRT projects typically encompass BRT development and other non-BRT components, although fund allocations are primarily allocated for BRT development. Project financing typically combines funding from the World Bank, government, and other development partners, with financing streaming in through different stages of implementation in the form of additional financing and grants.

Based on the review, the total financing amount for all completed IPF projects is \$4.1 billion, of which \$1.7 billion is financed by the World Bank.

Notes: Due to the wide range of data over two decades, the report extracts and estimates project financing and costs in U.S. dollars as is from the reported project documents. The cost data referenced specifically in this section as well as the entire report is not converted to the current year nor accounts for inflation. As a result, for example, the cost incurred in the year 2000 cannot be compared with the cost incurred in 2018.

At a global level, the World Bank only provided slightly over 40 percent of the total financing with the rest provided by national governments, other development banks

¹² World Bank <https://projects.worldbank.org/en/projects-operations/products-and-services/brief/projectcycle>

and partners, whereas in sub-Saharan Africa, more than 70 percent came from the World Bank financing.

The remainder of the financing mainly came from national governments, other development partners and Global Environmental Funds (GEF). For example, the Inter-American Development Bank (IDB) financed \$45 million in the Lima Project and the French Development Agency (AFD) financed two Africa projects: Accra (\$9.7 million) and Lagos (\$100 million). Five projects included GEF funds, ranging from \$4.5 million for Accra to \$16.7 million for India.

Figure 4.3-1: Project Financing at Completion (Converted to U.S.\$)

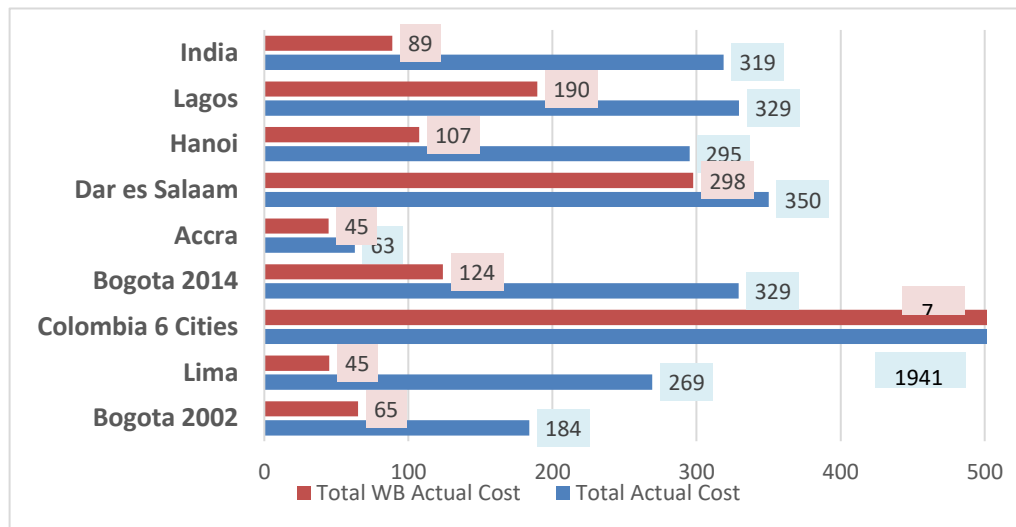

Note: Urban transport projects often have other non-BRT activities, such as urban roads, technical assistance and others. The costs in the figure include BRT and all other components.

Source: World Bank

4.4. Years of Implementation

Among the case studies, the earliest BRT financing occurred in Latin America, with the first BRT IPF project for Bogotá’s TransMilenio completed in 2002, followed by Lima, Colombia’s secondary cities, and then the expansion to Bogotá BRT. BRT developments then expanded internationally to Africa, East Asia and South Asia, as shown in the figure below.

Figure 4.4-1: Timeline of BRT Projects by Completion Year (as of September 2018)

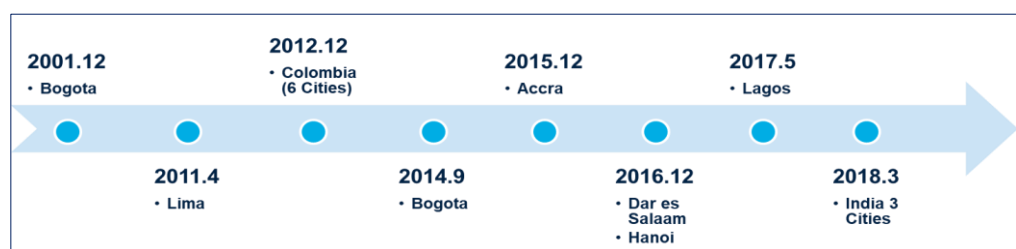

Note: Urban transport projects often have other non-BRT activities. The year of completion used here is based the beginning and the completion of the entire project, not only BRT the component.

Source: World Bank

Of the completed projects, implementation ranged from 5 to 11 years and the average length of time for implementation was 7.8 years. However, in the original schedules in Project Appraisal Document (PADs), the implementation only planned from 3 to 5 years with an average 4.6 years.

Among the nine completed BRT IPFs, the Bogotá 2001 project was the only one whose completed project adhered to the original plan in PAD. All other projects encountered delays that extended the project completion date, leading to internal World Bank project restructuring during the course of the project term. Contributory factors included utility relocation and land acquisition, changing local circumstances over multiyear implementations, political environment, schedule delays and cost overruns, and unforeseen risks sometimes beyond a city’s control. Some BRT projects doubled the implementation timeframe from the original plan.

Figure 4.4-2: Years of Implementation (Actual vs. Original Plan)

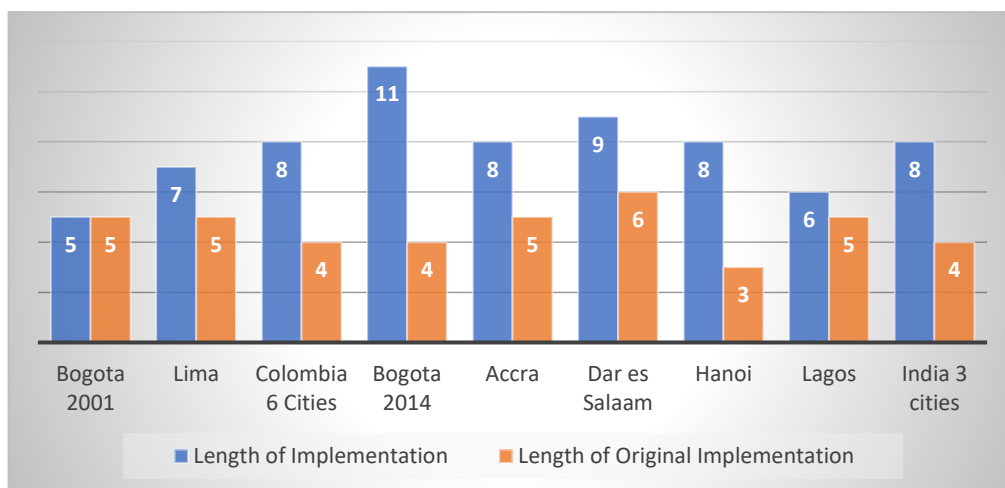

Note: Urban transport projects often have other non-BRT activities. The year of completion used here is based the beginning and the completion of the entire project, not only the BRT component.

Source: World Bank

This page intentionally left blank

Part 2. BRT Case Studies

This page intentionally left blank

5. Accra, Ghana



Accra was one of the first cities in SSA to initiate a BRT project in 2008. Accra established the institutional and regulatory framework as part of the project to incentivize broad policy reforms and build a platform to support BRT development. However, the project did not implement the BRT due to cost overruns, and the Government opted for a Quality Bus System (QBS)¹³ which improved services but lacks dedicated lanes for bus priority.

However, an outstanding achievement was the institutional reform initiated across all local assemblies, consisting of by-laws, regulations, procedures and an operator registration process to progressively register and license all local passenger transport services. The Greater Accra Passenger Transport Executive (GAPTE) was set up to plan and regulate passenger transport operations in the Metropolitan Area. An inclusive approach with the dominant informal sector, was able to navigate the political sensitivities to implement a formal permit system, which in turn has helped to incrementally improve service standards, create opportunities for commercial funding for larger and new(er) buses and operate more sustainable business enterprises.

A great deal has been learned from the regulatory reform and the QBS experience, and this will increase the chances of success of future efforts to improve public transport in Accra.



5.1. City and Urban Transport Context

Accra is the capital of Ghana and the largest city, and is the administrative, communications, and economic center for the country. The city is located on the Gulf of Guinea near the Atlantic Ocean. Accra has an estimated population of 2.3 million in 2012¹⁴, half of the population of the overall Accra metropolitan area. Accra's population is a very youthful one, with 52 percent of the population being under 24 years of age, as of 2010 Census.

Urban sprawl caused Accra to expand rapidly in the absence of proper planning, as the city shifted from a compact urban form to a decentralized urban sprawl. This made it difficult for local governments to provide the necessary basic services in urban areas. Dependence on cars caused Accra to reach a level of motorization having three times the number of cars per 1000 people than comparable African cities¹⁵.

¹³ QBS means the bus service operated on the type B corridor (e.g. based on route service agreements). It includes scheduled bus service supported by bus priority measures and infrastructure such as bus priority lanes (at certain times of the day), queue jumps at the intersections, exclusive left lanes, bus stops, bus terminals, and depots.

¹⁴ "2010 Population & Housing Census." Ghana Statistical Service. Archived from the original October 2014. Retrieved 14 January 2018.

¹⁵ PAD 2017 p29.

Poor quality public transport was a feature of Accra as the self-regulated informal ‘tro-tro’ system¹⁶ under the Ghana Private Road Transport Union (GPRTU) with a lack of reliability, disorganized routing and scheduling, and little quality control.

A fragmented institutional framework was unable to delineate responsibilities for the management of urban passenger transport amongst multiple overlapping agencies such as Metropolitan, Municipal, or District Assemblies (MMDAs). The city also lacked a higher-level authority to regulate inter-MMDAs transport.

Accra had previous experience with a bus priority which failed. In September 2005 at the time that BRT planning commenced, Metro Mass Transit Limited (MMTL) a quasi-government owned bus operator piloted its version of a bus priority system on the 20 km ‘Kimbu–Adenta’ corridor. This functioned until 2007 and should have provided lessons to heed for the later project. It provided frequent scheduled services and operated in dedicated bus-only curbside bus lanes, but its original overwhelming success was hampered by lack of enforcement of bus lane exclusivity and after two years it was replaced by a ‘regular’ service. Buses were then permitted to collect passengers enroute upon payment of fares, in common with tro-tro operators.¹⁷

5.2. Project Development Objectives and Schedule

The Ghana Urban Transport Project (GUTP) was a blended operation financed by International Development Association (IDA) credit, government funding, and a Global Environment Facility (GEF) grant.

The Project Development Objective (PDO) was to improve mobility in areas of participating metropolitan, municipal, or district assemblies (MMDAs). Components included: 1) setting up a regulatory framework and building the capacity of national and local institutions to manage and regulate urban passenger transport, 2) developing the BRT system, and 3) improving traffic engineering, management and safety.

The period of implementation was extended from five to eight years. While it was planned to be completed by 2012, three restructurings (2012, 2014 and 2015) saw the project finally implemented in 2017, but as a Quality Bus System without dedicated BRT lanes.

5.3. Case Analysis: Government Commitment

Institutional weakness was a contributor to the failure of the project. However, government commitment was consistently good, evidenced by the achievements in regulatory reform, namely the registration of operators into a licensing system.

¹⁶ Tro tros are minibuses seating 12–14 passengers and working along pre-defined routes.

¹⁷ Agyemang E. (2015) The bus rapid transit system in the Greater Accra Metropolitan Area, Ghana: Looking back to look forward, *Norsk Geografisk Tidsskrift - Norwegian Journal of Geography*, 69:1, 28-37, DOI: <https://www.tandfonline.com/doi/abs/10.1080/00291951.2014.992808> (last accessed 24/2/19)

A main weakness was in the lack of a clear ‘owner’ of the project and the high number of actors involved in the urban passenger transport sector, making the coordination of project activities difficult for BRT implementers, specifically the task of delineating stakeholders’ roles in the project vis-a-vis their established mandated responsibilities (Teko 2017:46). Feye et al. (2014:15)¹⁸ considered that *“the different institutions responsible for the planning and implementation of BRT were not organized and empowered to accomplish intended activities”* ...pointing to *“a remarkable weakness in institutional arrangement during the planning and implementation (which) is contributing to the failure of implementation of the project.”* Hence, there lacked a sense of common cause across the different Ministries and MMDAs. Institutional coordination between the Ministries of Transport, Local Government and Finance, in the form of Urban Transport Advisory Committee (UTAC), was accepted in principle but could not take hold.

Engagement with existing operators was a challenging task requiring strong and consistent government commitment. A strong and independent sector of existing operators represented by tro tro unions and operators (GPRTU and others) had for decades regulated themselves, where they acted as ‘both the referee and player’ (Teko 2017:46)¹⁹ and saw their role being usurped by local government. Their interests were divergent from the public institutions, being to safeguard the self-regulating style of operation they had practiced for years and to ensure that they continued to reap benefits to the advantage of their members (ibid:48), and whereas they presently considered themselves as owners of the system they were being asked to submit to regulation under a government-owned system.

These problems were alleviated over time, with extensive consultations and trust building, and finally the system of Type A and Type B permits system as envisaged in the project objectives, were delivered, ushering in a new regulatory framework for urban passenger transport, enabling a more sustainable commercial business model and encouraging investment into new(er) buses.

5.4. Case Analysis: Modification of BRT to QBS

Investments in BRT infrastructure (namely construction of the flyover and Odaw Bridge) absorbed most of management’s effort and budget. BRT planning took a lower priority, and together with subsequent funding constraints, the BRT component was ultimately dropped.

Changing to a Quality Bus Service (QBS) alternative marked a significant compromise to the project. Its most impactful disadvantage is the lack of dedicated BRT lanes that have

¹⁸ Feye GL, Evia P, Benefoh D. (2014) Doctoral Studies Paper University of Bonn. Comparative assessment of success and failure factors for implementation of Bus Rapid Transit system in Accra and Bogota

Source: https://www.zef.de/fileadmin/downloads/forum/docprog/Thermpapers/2nd_rank_Bus_rapid_transit_in_Accra_and_Bogota.pdf Last accessed 22/03/2020

¹⁹ Teko E. 2017) (p46) The Bus Rapid Transit Project in Accra, Ghana: Institutional factors affecting its implementation (Thesis). MSc Programme in Urban management and Development Rotterdam Netherlands Source: <https://thesis.eur.nl/pub/42383/13.pdf>. Last accessed 03/02/2019

affected efficiency (thus financial viability) and public perception. Researchers undertaking public opinion surveys (Teko 2017:42,43) found that most respondents identified traffic congestion and lack of dedicated lanes as reasons for the failure of the system, laying the blame on poor leadership by project implementers. They opined that apart from the financial cost implications of constructing or delineating bus lanes, there seemed to be no firm technical direction to lead the process. All respondents indicated that the implementation of the original BRT idea failed and the QBS did not meet their expectations.

It can be argued that if the project had at least persisted in the demarcation of traffic priority for buses, the system would have performed well. Bus priority may have assisted the financial situation that now faces the GAPTE, as traffic congestion has an ongoing impact on fleet productivity and ridership.

Despite initial ridership growth on the QBS increasing from about 5,000 to 11,000 passengers per day, poorly conceived business models led to a steady decline in operating revenues. This resulted in losses of \$1.6 million in 2016 and \$1.9 million in 2017 and as result, bus services were temporarily suspended (TUMI)²⁰. In 2018 QBS reinstated bus services, recently deploying 50 buses with plans to deploy up to 180 buses as part of a restructured system of routes and operation²¹. QBS is making proposals for dedicated bus lanes along the routes, and recently some sections of the route operate as bus priority during certain periods.

5.5. Case Analysis: Institutional Deficiencies

Two challenging institutional factors played a role in how things turned out in the Accra BRT project.

The new institutional arrangements were not sufficiently robust as a political, regulatory or coordinating entity to undertake implementation of a major sector reform and a BRT implementation project at the same time. Attempting full-scale sector reform in parallel with building a new urban transport system proved too ambitious and over-stretched resources. Despite the challenges, the introduction of a comprehensive regulatory framework for urban passenger transport helped to reorganize existing operators to meet formal sector requirements for business establishment, instead of trying to replace them with a new formal system. The engagement with existing operators and a transition to the new bus permit system is a major achievement.

The 'management agency' needs to be equipped to manage, not just regulate. GAPTE was established as the system regulator, thus lacking the management capacity to deal with the operational challenges. Its role is to deal with cross-jurisdictional issues of

²⁰ Transformative Urban Mobility Initiative (TUMI) Source: <https://www.transformative-mobility.org/assets/publications/1.-TUMI-City-profile-and-story-Accra.pdf> (Last accessed 5/11/2019)

²¹ gbconline.com (2019) Source: <https://www.myjoyonline.com/news/2019/September-13th/50-aayalolo-buses-deployed-on-accra-roads.php> (Last accessed 13/09/2019)

regulation, development and organization of urban passenger transport. Its functions include regulation, permit issuance, transport planning, and ticketing and pricing.

However, as regulator it should be managing the 'risk-takers' not taking the risk itself (which it cannot manage). The lack of a dedicated agency to manage the BRT itself is detrimental to system performance. The Chief Executive of the Accra Metropolitan Assembly, Mohammed Nii Adjei Sowah, declared the system in "*dire financial straits*" (July 5, 2018), suggesting a separate company be allowed to manage the BRT system²², mirroring that of a State Transport Corporation (STC), as "*GAPTE was intended as a regulatory body, not equipped to manage operational issues and does not have the financial muscle to continue managing the BRT system*".

Transformative Urban Mobility Initiative (TUMI)²³ have suggested that the system could have been operated by re-organized public transport service providers, while acknowledging that the lack of dedicated bus lanes and bus stops negatively impacted on the efficiency and profitability of bus routes.

This posits that a private operator may be placed take some or all of the revenue risk if they could benefit from dedicated bus lanes.

5.6. Case Analysis: Lessons Learned

Overemphasis on large infrastructure components was detrimental to the project as a whole. Spending one-third of project funds on the Odaw Bridge and the Circle flyover along the BRT corridor, left severe budget constraints and crippled the chances of delivering the BRT, thus failing on the main project objective. In hindsight, designing an at-grade BRT (within budget) and accepting slightly lower efficiency (operating speeds) may have been a more prudent option.

Opting for a QBS did not deliver an efficient system nor did it meet the public's travel expectations. This emphasizes the critical need for bus priority on dedicated lanes or other measures that improve operational efficiency. A 'quality bus system' quickly becomes compromised if buses operate in congested traffic.

The need for a clear 'owner of the project.' A clear understanding of 'ownership' is key to the reform program and helps facilitate coordination across multiple stakeholders and could have mobilized the MDAs and MMDAs to common actions.

New institutions need a strong and clear mandate (especially if operating across multiple jurisdictions) and be well resourced to develop their functions and capacity. A newly created and inexperienced GAPTE entity lacked project monitoring skills, missing critical data and resulted in poor decision-making as the project progressed.

²² City News Room: 5 July 2018 STC Management Approach Required To Manage BRT System

Source: <https://www.modernghana.com/news/865939/stc-management-approach-required-to-manage-brt-system.html> (LA 10/7/2019)

²³ TUMI is a partnership of high-level organisations promoting sustainable transport worldwide.

BRT requires system management not just regulation. When the government took the financial risk, it needed the management capacity to manage that risk, but GAPTE acting as a high-level regulatory body is not equipped for this task. As a result, the system faces financial challenges. A mid-level business entity (company) to manage the system as suggested by the Chief Executive of the Accra Metropolitan Assembly, is a worthwhile proposition.

Project management issues can seriously affect project outcomes. Practical engineering matters also influenced outcomes, with incomplete BRT designs and bid documents leading to project delays, design changes and cost overruns. Both were not complete at the time of entering implementation. Scope change, implementation delays, cost overruns, affected the projects' efficiency. The cost for the bridge and flyover increased by 60 percent.

6. Bogotá, Colombia (UTP & USP)



Bogotá's TransMilenio has been a beacon of BRT innovation and has exhibited excellent planning characteristics, delivering extensive benefits to its population. Most notable was a socially inclusive approach, in that Bogotá did not build the BRT as an end in itself, but took a different approach to sustainable urban mobility, implementing a comprehensive strategy to regenerate the urban fabric and connect distant and disperse low-income areas to economic and social opportunities.

The decision to go with BRT as opposed to a rail system was made to deliver faster implementation at a lower per-km cost. Bogotá was remarkable in its political maneuvers that brought existing stakeholders on-board, structuring bus contracts to partner existing operators with international players. Underpinning its success, was the establishment of TransMilenio S.A. as a publicly-owned network manager with a regulatory model of privately-run services, which included the restructuring of existing operators. The Phase I BRT increased commercial bus travel speed from 18 km/h to 28 km/h and reduced accidents by more than 80 percent.

The second and third phases of Transmilenio were more challenging to implement due to increased infrastructure costs (guarding against the experience of premature deterioration of Phase 1 infrastructure) and Phase 3 encountered resistance to the city-wide SITP bus reform by traditional bus operators. The first phase of the system, particularly the congested Caracas corridor, has now operated at over-capacity for more than 5 years, and requires upgrading to improve its aging infrastructure. There is consensus that the city still needs to advance with the implementation of additional high-capacity corridors as a strategy to improve quality of service and access to transport for a growing travel demand.



6.1. City and Urban Transport Context

Bogotá is the capital city of Colombia and the largest and most populous city in the nation. It has a population of 10.98 million (2020) and a population density of approximately 4,300 per square kilometer²⁴. Due to significant growth in private cars since the 1980s, Bogotá experienced severe air pollution during peak travel hours, long commuting times, and high accident rates.

In the 1990s Bogotá's disorganized traditional bus system was ripe for improvement – being dangerous, inefficient, and offered poor-quality service²⁵ with an oversupply of

²⁴ <http://worldpopulationreview.com/world-cities/bogota-population/>

²⁵ Turner M. Kooshian C. Winkelman S. (2012) Case Study: Colombia's Bus Rapid Transit (BRT) Development and Expansion. An Analysis of barriers and critical enablers of Colombia's BRT systems.

route permits and weak institutional capacity. Bus operators were disorganized and competed in 'penny wars' for passengers²⁶.

Planning in 1991 did not start with BRT, but involved comprehensive transport strategies of an integrated mass transit system, consisting of both bus and Metro rail concessions. However, the city was wary of a rail project due to the experience in Medellín, which had faced severe cost overruns and delays in their Metro project. Bogotá thus developed foundational strategies for the development of the eventual BRT, including restructuring the institutional framework to make it more accountable and responsive to sector needs and optimizing the capacity of existing infrastructure through traffic management, among others.

Figure 6.2-1: Bogotá's BRT Phase 1 & 2 Photos



Source: Gerhard Menckhoff

6.2. Project Development Objectives and Schedule

The overall objectives of the **Bogotá Urban Transport Project (UTP 1996)**²⁷ were to: (a) improve major transport corridors by rationalizing vehicle flows and upgrading environmental conditions for users; (b) promote the use of public transport and non-motorized transport modes; (c) facilitate public transport access to areas of low-income population; (d) extend the life of road infrastructure; and (e) strengthen the institutions in charge of planning, managing and maintaining transport infrastructure.

BRT Phase 1, along Calle 80, Av. Caracas, and Autopista Norte, comprised 34.2km taking six years to complete, commencing operations in 2002.

BRT Phase 2 along Av. Suba under the **Bogotá Urban Services Project (BUSP P074726)** commenced in 2003. Implementation was anticipated at four years but after restructuring and additional financing in 2008, the project took 11 years, closing in 2014. The project development objective (PDO) of the BUSP was to improve urban living conditions by increasing access, coverage, quality, reliability, and improving inter-agency coordination through public transport, sanitation services and potable water.

²⁶ Arturo Ardila (2007) How Public Transportation's Past is Haunting its Future in Bogota, Colombia. Journal of the Transportation Research Board, No. 2038. Source: <https://doi.org/10.3141/2038-02> Last accessed 22/03/2020

²⁷ WB Staff Appraisal Report (1996)

BRT Phase 3 along Av. NQS Central and North (Phase 2) was implemented under the **Colombia National Urban Transport Program (NUTP)** and was completed in 2012. In total, Bank finance supported five corridors totaling 58 km as shown in Table 6.2-1.

Bogotá’s TransMilenio has been an innovative project, with excellent planning characteristics delivering extensive benefits to its population. Its successes have led to the idea of exporting the TransMilenio ‘concept’ to other cities.

Table 6.2-1: Expansion of Bogotá’s BRT in 3-Phases

BRT Corridor	Length (km)	Number of stations	Start date (operations)
BRT system – phase 1			
Calle 80	10.1	12	January 2001
Av. Caracas	11.9	14	January 2001 August 2001 ⁱ February 2002 ⁱⁱ
Autopista Norte	10.3	15	August 2001 ⁱ
Av. Jiménez	1.9	3	June 2002
Subtotal phase 1	34.2	44	
BRT system – phase 2			
Av. Americas – Av. Calle 13	13.0	16	November 2003 ⁱⁱⁱ June 2004 ^{iv}
Av. NQS Central	10.6	11	February 2005
Av. NQS South	12.7	15	April 2006
Av. Suba	13.0	13	April 2006
Subtotal phase 2	49.3	55	
BRT system – phase 3			
Av. Calle 26	12.2	13	June 2012 ^v October 2012 ^{vi}
Av. Carrera 10	7.3	9	October 2012
Subtotal phase 3	19.5	22	
Total all phases	103.0	121	

Notes: ⁱ Expansion of Phase 1 with the opening of BRT Terminals Usme and Portal Norte; ⁱⁱ Opening of BRT Terminal Tunnel; ⁱⁱⁱ Started operations until BRT station Banderas; ^{iv} Opening of BRT Terminal Portal Americas – full operation started; ^v Started operations with some BRT station and the BRT Terminal El Dorado; ^{vi} Full operation started.

Source: Global BRT Data, 2017; EMBARQ, 2009; TransMilenio SA.

Source: Colombia Ministry of Transport

Figure 6.2-2: Map of the Full TransMilenio Network

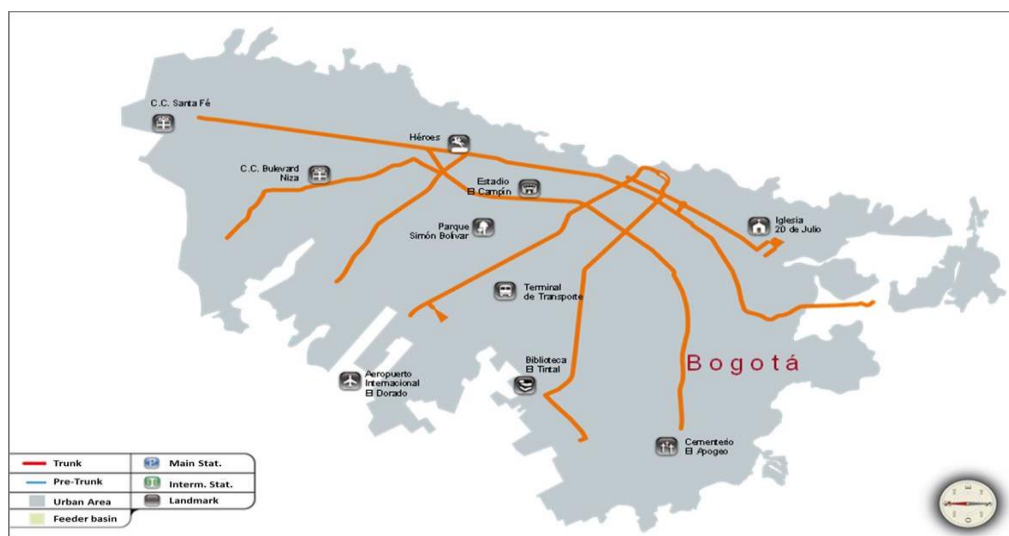

Source: Colombia Ministry of Transport

Table 6.2-2: TransMilenio System Statistics 2017

(Data: 2015)	Population	Urban Area, km ²	Density, pop/km ²
Bog Metro Area	8,062,610	461	17,500
Indicator	Units	Value	
Daily Ridership	passengers	2,676,000	
Revenue, COP	COP M	\$ 2,271,000	
Revenue, 2018 USD M	2018 USD M	\$	750.0
Trunk line length, 2017	KM	114.00	
Stations, 2017	#	146	
Trunk lines, 2017	#	9	
Fleet, 2017	#	1,934	
Fare, 2019	COP	\$	2,400
Fare, 2019 USD	2018 USD	\$	0.79
Speed	km/h	24	

Source: Leonardo Canon Rubiano based on official data

6.3. Case Analysis: BRT System Design

Bogotá's BRT started with an existing busway scheme developed along an 8km southern section of the Av. Caracas by the City Government in 1989-90. Building upon this existing corridor, the objective of the UTP project was to improve its operation and develop an 8-km extension of the Southern busway to the North, and the busway system along Calle 80, including the reorganization of bus routes, re-configuration of the road network, traffic management works and junction improvements and various other measures to improve the corridors.

The design of the BRT under the UTP Phase 1 was a dedicated BRT trunk route operating as a closed system with a feeder bus system. The trunk line corridors were: Av. Caracas, Autopista Norte (Autonorte) and Calle 80. Phase 1 consisted of 41 km of BRT lanes, 60 stations, 470 articulated buses, and 258 feeder buses. About 1.5 km runs through a pedestrianized area in the historic city core and 2.7km runs in mixed traffic. 39 feeder bus routes are operated by 80 passenger buses and serve terminals located at the ends of the busways and at selected stations along trunk lines. Bogotá's BRT Phase I set the system design standards²⁸ for high capacity BRT systems.

The BRT trunk line fleet consisted of 18-meter, articulated diesel vehicles with a nominal capacity of 160 passengers (6 passengers per sq. meter). After 2010, TransMilenio introduced 24-meter, 240 passenger bi-articulated buses. High-entry doors (90 cm above ground level) are located on the left side of the buses to serve central median stations. The entire fleet is equipped with modern automated vehicle location (AVL), fleet management (FMS) and visual and audible User Information (UIS)

²⁸ Fact sheet on TransMilenio Busway-Based Mass Transit, Bogota, Colombia, by John Cracknell for the World Bank, 2003

systems. All stations are equipped with a modern fare collection system that uses contactless farecards.

6.4. Case analysis: Operations Management – key features

Bogotá has introduced institutional arrangements that have become a model for other cities in managing BRT. Commercial management and accountability for performance feature strongly.

Key features are:

- (i) In general, operators are paid on a per-km basis and penalized with a discount applied if they do not meet the standards and levels of service parameters which are set out in a legally binding operational manual.
- (ii) The Government of Bogotá established TransMilenio S.A. as an agency of the Bogotá government (a publicly-owned commercially-driven company) to manage the BRT system and other modes of formal public transport, which now includes city buses (SITP) and a cable car line. TransMilenio receives 4 percent of fare proceeds to partly cover its management costs.
- (iii) TransMilenio was registered as a Clean Development Mechanism (CDM) in 2006, earning US\$25 million in carbon credits by 2012.
- (iv) In Phase 3, the city embarked in a city-wide reform of the bus sector, restructuring and tendering routes operating in mixed traffic with the objective to improve the quality of service and to eliminate competition ‘in the market’ opting instead towards competition ‘for the market’. Despite setbacks and operational and financial challenges, Bogotá managed to reform its traditional urban buses into a regulated, concessioned system with restructured bus routes, and operational, fare and infrastructure integration with TransMilenio’s BRT²⁹.
- (v) **A significant challenge to management, is higher-than-expected passenger volumes.** This additional demand, combined with bottlenecks occurring during certain periods, and suboptimal service plans led to passenger overcrowding and bus bunching in the segments of highest demand. Primarily contractual constraints, coupled with a perception of uncollaborative scrutiny from comptrollers,³⁰ prevented TransMilenio from increasing the size of the fleet, suggesting that the agency failed to address passenger comfort due to the mandate of financial self-reliance.

6.5. Case Analysis: Institutional Arrangement

Bogotá’s success story is largely due to its ability to introduce TransMilenio S.A. as network manager to manage the business of public transport, restructure existing operators, and build a regulatory model of privately-run services.

²⁹ Bogota’s Bus Reform Process: Accessibility and Affordability Effects, Lessons Learned and Alternatives to Tackle Informal Services. Camila Rodriguez, etc., 2016.

³⁰ Mayor Peñalosa running for re-election, characterized bus overcrowding not as a capacity issue, but as an operations and financial issue, citing that current operating costs were too high.

Public works were delivered by the city's infrastructure delivery agency – the Urban Development Institute (IDU). TransMilenio S.A agency evolved from being an 8-person office next to the Mayor to an agency with over 500 staff in charge of planning, operations, concession management and maintenance of a city-wide system.

TransMilenio S.A. has set standards for BRT concession management and is still a reference when looking at BRT concession contracting. It introduced time-bound, performance-based remunerated concessions that transformed the fleet acquisition, operation and maintenance standards, formalized crews, and complies with labor, tax and sectoral laws and regulations. The robust legal framework under which concessions operate, together with enforcement (and reward mechanisms) developed a skilled bus operator sector.

Bogotá's TransMilenio BRT provides a good example of engaging with incumbent operators, formalizing them into professional operations. Partnering with international operators to bid for contracts introduced skilled management and technology in what was otherwise a low capacity environment, proved a pivotal step in upgrading operator's skills.

6.6. Case Analysis: Financing CAPEX

Bogotá city is responsible for managing its entire transportation system, including roads, non-motorized transport, and regulating public transportation and automobiles. To fund this the city collects taxes, which first go to the Secretariat of Finance (SF), who then distributes them to agencies. These taxes cannot be earmarked for special purposes.

Three other city agencies are also involved: 1) the Urban Development Institute (IDU), which operates in part as a road fund to guarantee an adequate and reliable source of revenue to fund the transportation system, 2) the Secretariat of Mobility (SM), and 3) TransMilenio SA.

Notable in Bogotá is its funding mechanisms for CAPEX. The transfers from the city government are from a surcharge on fuel, both gasoline and diesel but excluding natural gas. **Colombian law establishes that the proceeds of this surtax on fuel are earmarked for the CAPEX of the transportation system.** The fuel surtax commenced at 15 percent in 1997 but by 2005 had been increased to 25 percent nationwide³¹. Specifically:

- 50 percent of the revenue goes to the construction of mass transit systems, such as TransMilenio BRT;
- 20 percent for construction and maintenance of local streets, specifically roads that provide access to neighborhoods;
- Another 20 percent is earmarked for construction and maintenance of the arterial road network;

³¹ Gomez, AA. Ortegon, A. (2013) Finances of Bogota's Transportation System WCTR Rio 2013 Selected proceedings

- 10 percent of the revenue goes to the 20 local governments within Bogotá.

In 2006 transfers from the national government were earmarked to cover 75 percent of the construction cost of the second and third stages of the TransMilenio BRT project. The IDU can also execute projects that are funded through loans from international institutions, such as the World Bank and the Inter-American Development Bank, made to the city of Bogotá.

The fuel surcharge allowed the city to raise important resources to invest in the successful TransMilenio project, which in turn, attracted additional funds from other sources, such as national government or global fund sources, creating a virtuous cycle to fund the system. This is in contrast to an earlier 1988-92 low-cost, low-quality busway project which could not attract additional revenue to the system (ibid).

6.7. Case Analysis: Financing OPEX

At the outset of the contract bidding process, TransMilenio's business model was designed to be self-financing, with a technical fare structure designed to follow the cost recovery principle where 100 percent of its OPEX (including fare collection system and bus fleet) are met through passenger fares. Operators are paid on a km-basis as per their bid price for the contract with adjustment formulas for rises in labor and fuel costs over time. They also receive a share in the revenues generated on account of the commercial exploitation of the TransMilenio System (Contract Clause 46 & 47).

Fares are periodically adjusted, and there is a mechanism to set aside any revenue surplus to cover for deficits occurring between fare adjustments. The national and city governments initially provided no subsidy support, only covering capital costs of infrastructure³². However, the 'cost recovery from fares' paradigm proved difficult to manage as financial constraints indirectly caused fleet reduction and routing rationalization to try to match cost and revenues³³ - it also caused pressure on user-tariffs. Following legislative changes introduced by the 2015 National Development Law (Law 1753 of 2015), Bogotá moved away from the principle of fare revenues needing to equal OPEX, towards a principle of financial sustainability, gaining access to other funding sources (budget transfers, ancillary business, parking tax, congestion charge, tolls, etc.) to supplement fare revenue to cover costs.

The system charges a flat-fare (no discounts) established at US\$0.40 in 2000 and fares could be increased regularly to keep up with cost inflation, being progressively adjusted to US\$0.61 in 2017. At the same time, the decision on fare increases is also political. Financial difficulties arose when a new Mayor kept fares unchanged for four years.

Full cost recovery from fares demands higher efficiency and productivity as compared to traditional buses (measured in terms of passenger per km index and passenger per bus per day index). Achieving this higher efficiency in Bogotá prompted bus **overcrowding**,

³² ESMAP (2009) GOOD PRACTICES IN CITY ENERGY EFFICIENCY Bogota, Colombia – Bus Rapid Transit for Urban Transport

³³ Gomez-Lobo, A. 2019 BRT Reforms in Colombia: an ex-post evaluation

Source: https://www.researchgate.net/publication/333039992_BRT_Reforms_in_Colombia_an_ex-post_evaluation LA 11/07/2019

which negatively impacted on comfort and safety³⁴ and customer satisfaction and had knock-on effects on fleet efficiency, increasing dwell times, reducing fleet productivity³⁵ with in-bus crowding increasing boarding and alighting times.

6.8. Case Analysis: Expansion Challenges and Evolving Issues

The second and third phases of Transmilenio were more challenging to implement because of increasing CAPEX costs (Phase 2), political battles and the implementation of the city-wide bus reform (Phase 3), which generated resistance from traditional bus operators. As a result, TransMilenio expanded very slowly in the last decade.

Key issues included:

Growing system and institutional complexity and resistance from traditional operators.

While Phase 1 gained early success and rallied political support, Phases 2 and 3 faced difficult operational challenges. Traditional bus operators opposed changes and organized against the Mayor during the citywide bus reform of Phase 3, resisting the bus scrapping program that required incoming operators to ‘scrap’ up to three old vehicles in exchange for a license to operate a new one, and demanding higher compensation for their old buses.

A historically bureaucratic problem is that TransMilenio, while in charge of station repairs and fleet scheduling, is reliant on the Urban Development Institute (IDU) for construction of new infrastructure and the maintenance of busways. More than once, delays with infrastructure contracts or even repaving plans under IDU’s purview have impacted on TransMilenio’s operations.

Preserving service quality at high passenger volumes is an ongoing challenge³⁶. Travel demand continued to increase in the same corridors, resulting in overcrowding problems at stations and on buses. In the case of Phase 2 Line, the inability to add buses contributed directly to overcrowding. On some occasions, the combination of waiting times for feeder and trunk buses meant that overall, passengers had to wait longer under the BRT system than the traditional bus system, leading to negative public opinions and reduced public support.

An aging BRT system in need of reinvestment. Political battles and lack of continuity have resulted in an aging bus fleet for which its replacement is now eight years overdue (nearly 1,400 buses are arriving as of July 2019). Technological systems (fleet management, user information) are also outdated and in need of improvement.

Significant investments in infrastructure, fleet and technology, timely maintenance and continuous multimodal expansion are necessary to reverse the negative aspects and improve service quality³⁷.

³⁴ Hidalgo, D. Carrigan, A. (2010) Built Environment, Volume 36, Number 3, 13 October 2010, pp. 283-297(15)

³⁵ Hoel, L. Garber, N. Sadek, A. (2010). Transportation Infrastructure Engineering: A Multimodal Integration, SI Version, p. 177. Cengage Learning. ISBN 0495667897

³⁶ FTA (2007) Report on South American Bus Rapid Transit Field Visits: Tracking the Evolution of the TransMilenio Model

³⁷ Gomez-Lobo, A. 2019 BRT Reforms in Colombia: an ex-post evaluation

Source: https://www.researchgate.net/publication/333039992_BRT_Reforms_in_Colombia_an_ex-post_evaluation LA 11/07/2019

Figure 6.8-1: Bus Congestion on the Busway

Source: <https://use.metropolis.org/case-studies/transmilenio-bus-rapid-transit-system>

Figure 6.8-2: Congestion Affecting Service Efficiency

Source: <https://theBogotápost.com/Bogotá-transmilenio-system-a-painful-route-to-the-future/1177/>

6.9. Case Analysis: Lessons Learned

Bogotá's TransMilenio case study shows both innovative excellence and challenges relating to complex political, financial and operational issues, some of which require long-term engineering or policy solutions³⁸.

As a model for transport reform and BRT, TransMilenio delivered large improvements in travel time, reduction in pollution and accidents and other mobility measures such as non-motorized transport (NMT). It serves as a model for World BRT systems and under a national policy (NUTP) it has been replicated in other Colombian cities (but with varied results).

Solid planning objectives were evident early in the project. The real recipe for Bogotá's BRT success is understanding its solid planning objectives and comprehensive approach³⁹. The project was conceptualized and formulated after a thorough analysis of urban development and transport issues in Bogotá, on the institutional framework and responsibilities, the performance of the sector agencies, the sector investment plans, local finances and issues and strategy. This resulted in (a) a high degree of consistency between the project objectives and the priorities of the municipal administration in Bogotá; (b) goals and objectives which took account of the existing conditions and included components which had a high poverty focus; and (c) the project design was formulated to take account of the complex institutional, financial, legal and regulatory frameworks, with a realistic assessment of the possible risks during project implementation (ibid).

Cost recovery through fares was aspirational, but affected customer satisfaction and became challenging in a context where citywide bus reform would cover 100 percent of bus services. Subsidy-free operation played off against customer satisfaction is an

³⁸ WRI (2011) Cityfix: TransMilenio: The Good, the Bus and the Ugly Source: <https://thecityfix.com/blog/transmilenio-the-good-the-bus-and-the-ugly/> LA 9/10/2019

³⁹ WB Staff Appraisal Report (1996)

imprudent choice, and particularly impacts the most vulnerable low-income user groups. After 2015, the law defined financial sustainability as the objective, allowing other sources of funding (parking, fuel tax, municipal budget allocations) to improve financial support. This amendment recognized the added cost of formalizing transport, and that the additional cost burden should be borne by society as a whole, not just public transport users, who are primarily the low-income sector.

Given high levels of demand, the system faces ongoing challenges of overcrowding and route complexity. Bogotá's TransMilenio serves as a lesson in good practice, but *reaching the scientific limits on passenger loads is of little advantage to the user, if quality is compromised.* Managing high levels of capacity results in complex route designs, operating a large number of routes (regular and express services) along a few corridors, which can be confusing for users. Express buses, while able to reduce in-vehicle time, has the effect of increasing waiting times.

While long term solutions are needed, immediate steps can be taken to improve service quality. There is a need to revamp and simplify routes to improve travel efficiency, and citizens' participation in this optimization process will be fundamental⁴⁰. However, while technical planning and longer-term engineering and policy solutions are needed⁴¹ more immediate work can be done on issues involving customer morale and education, including passenger information and wayfinding guidance and courtesy programs to aid and assist users about etiquette on the TransMilenio. Such action may reverse the negative attention the media has given the system. Nevertheless, as stated by Hidalgo⁴² *"The key is first to improve the quality of the service and then user education, not the other way around.....You can't tell people to behave if they are mistreated."*

TransMilenio serves 'metro capacity' passenger volumes, suggesting that building a metro is warranted, but BRT plays a key role. It cannot be overlooked that Bogotá built an impressive, extensive mass transit system for a fraction of the cost of a metro and offers a much wider coverage. This demonstrates that BRT can serve as an essential 'stepping-stone' to mass transit and even after the first metro is built, the BRT still represents most of what is an extensive mass transit network. One thing is certain, that when the metro is built, it will certainly have enough ridership.

Vested interests can undermine the viability of a new BRT system⁴³. BRT development is never a stand-alone or singular intervention, and can disrupt existing power structures and infringe on vested interests. In the case of Bogotá, there were negative spillover effects with bus oversupply on routes where displaced buses were relocated. Traditional operators were also able to exploit the bus scrapping system for gain,

⁴⁰ Source: WB Group Source: <https://blogs.worldbank.org/transport/bogota-transmilenio-s-overcrowding-problem-and-professors-solution>
Last accessed 31/03/2019

⁴¹ WRI 2011) Cityfix: TransMilenio: The Good, the Bus and the Ugly Source: <https://thecityfix.com/blog/transmilenio-the-good-the-bus-and-the-ugly/> Last accessed 9/10/2019

⁴² See: EMBARQ's guidebook, "From Here to There: A Creative Guide to Making Public Transport the Way to Go."
Source: <http://www.embarq.org/en/news/11/05/26/new-guidebook-from-here-to-there> Last accessed 10/10/2019

⁴³ This section draws upon p457-460 Gilbert A. (2008) Bus Rapid Transit: Is Transmilenio a Miracle Cure? Transport Reviews A Transnational Transdisciplinary Journal Source: <http://www.informaworld.com/smpp/title~content>

adding buses to the already over-supplied market and inflating bus values to exploit the scrapping program. The large influence of individual bus companies on members of the city council have made it difficult to resolve these problems.

There is a lesson for planners to be mindful of spillover effects in the risk analysis which are often obscured by optimism in the BRT's benefits. For example, with the operation of a BRT, the user's total trip travel time may increase (if transfers are factored in) and fares cease to be negotiable. This shows that for a successful outcome, transport interventions need to be treated holistically, and will also require parallel regulation of traditional public transport competitors⁴⁴.

⁴⁴ Echeverry, Juan & Ibañez, Ana & Moya, Andres & Hillón, Luis. (2004). The Economics of TransMilenio, a Mass Transit System for Bogota. Journal of LACEA Economía. 5. 10.1353/eco.2005.0014.

This page intentionally left blank

7. Colombian National Urban Transport Program (6 Cities)



The decision of the MoT of Colombia to emulate Bogotá's BRT in other cities under the National Urban Transport Program scheme (NUTP) is an excellent demonstration of a national leadership, giving political emphasis and offering technical assistance and a proportion of the funding required for cities to undertake their own BRT projects. It appears unlikely that cities would have been able to generate these projects locally. At completion, BRT in Colombia's 6 cities directly benefited low-income populations, with data indicating that the percentage of low-income user groups using BRT was 39 percent in Bogotá, 71 percent in Barranquilla, and 61 percent in both Pereira and Bucaramanga. User satisfaction in Pereira and Barranquilla was very high, but less favourable in Bucaramanga reflecting the initial limited coverage.

Collaboration between the national and local government was crucial to the success of the mass transit system development in Colombia. Once the national initiative had taken root, cities were able to work upwards from the grassroots level to define needs and solutions within their local context, including the introduction of pre-trunk services in Barranquilla, Medellín and Cartagena, and the integrating BRT into the business of Metro Rail in Medellín. Nonetheless, the BRT systems experienced a lack of financial sustainability amidst lower than expected passenger demand.



7.1. National Program Introduction

In 2002, Colombia championed the National Urban Transport Program (NUTP) which included implementing SITM reforms (Integrated Mass Transit System) and expanding BRT systems in Colombia's medium and large-sized cities. A key intervention for each city was using the BRT project to define a new regulatory framework as a response to operational problems and negative impacts of traditional public transport, which was highly competitive leading to oversupply of buses, low productivity, and accidents. Two aspects of BRT feature heavily in this national program, namely: 1) financial sustainability, and 2) using PPPs to engage the private sector.

This national BRT program resulted in seven cities being selected, of which six were supported by WB financing, namely: Bogotá (Transmilenio), Barranquilla (Transmetro), Bucaramanga (Metrolinea), Cartagena (TransCaribe), Pereira (Megabus) and Medellín-Valle de Aburra (Metroplus). Cali was the remaining city supported by funding from IADB.

7.2. Project Development Objectives and Schedule

The PDOs were to:

- Objective 1: Develop quality and sustainable BRT systems in selected medium and large cities to improve mobility along the most strategic mass transit corridors;
- Objective 2: Improve accessibility for the poor through feeder services and fare integration;
- Objective 3: Build greater institutional capacity at a national level in order to formulate integrated urban transport policies, and at the local level to improve urban transport planning and traffic management.

The total period of implementation for the project was seven years from 2005 to 2012. The WB closed the project in 2013.

7.3. Pereira (Megabus)

Pereira is the capital city of the Colombian department of Risaralda and the second-most populated city in the Paisa region, after Medellín. Pereira is part of the wider conurbation of the Central West Metropolitan Area (AMCO)⁴⁵. In 2015, the estimated population was 486,000 with a density of 10,000 people per sq. km⁴⁶.

BRT operations began in 2006, with two bus operators (Integra, Promasivo) and an AFC concessionaire. This was the second BRT system to start operations in Colombia. Public works were delivered by the SOE Megabus, which acts as mass transit authority of the BRT.

Figure 7.4-1: BRT Routes in Pereira (2015)

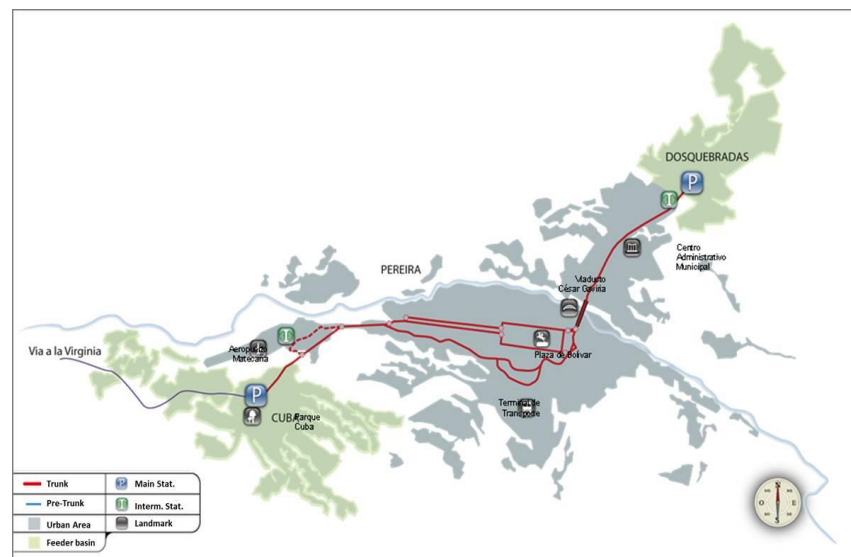

Source: Ministry of Transport, Colombia

⁴⁵ "Estimaciones de Población 1985 - 2005 y Proyecciones de Población 2005 - 2020 Total Municipal por Área (estimate)". DANE. Retrieved 10 November 2016.

⁴⁶ Leonardo Canon Rubiano based on official data

Table 7.4-1: Pereira BRT Data

Indicator	Units	Value
Daily Ridership	passengers	89,000
Revenue, COP	COP M	\$ 60,106
Revenue, 2018 USD M	2018 USD M	\$ 19.9
Trunk line length, KM	KM	17.60
Stations	#	45
Trunk lines	#	3
Fleet	#	53
Speed	Km/h	18
Fare, 2019 USD	2018 USD	\$ 0.69

Source: Leonardo Canon Rubiano based on official data, 2015

7.3.1. Pereira - Notable Achievements

Strong leadership and engaging in public participation in the implementation stage involving two municipalities. The leadership of Megabus' General Manager (Mónica Vanegas) had a powerful demonstrative effect – showing that it was possible to generate the technical and institutional capacity to deliver a large urban transport infrastructure project outside Bogotá. This leadership ensured ongoing mayoral support in the city of Pereira from three different administrations. The formation of a planning and implementation team separate from the local transport and public works departments ensured there was enough capacity to develop system components.

Several critical strong enablers contributed to the success of Megabus⁴⁷:

- Resettlement plans minimized social disruption and gave fair compensation to all affected groups, including the vulnerable population.
- Regulation and control were instrumented through binding contracts awarded after a competitive process. In the selection process, priority was given to existing operators and bus owners.
- The participation of all seven transport companies, and some bus owners, enabled important stakeholders to contribute to the planning, and this led to a successful competitive bidding process.

7.3.2. Pereira - Challenges and Lessons

- Construction delays (including external factors such as availability of funding and safeguards) caused pressure to launch operations with only partial infrastructure and temporary facilities.

⁴⁷ Turner M. Kooshian C. Winkelman S. (2012) Case Study: Colombia's Bus Rapid Transit (BRT) Development and Expansion. An Analysis of barriers and critical enablers of Colombia's BRT systems Mitigation Action Implementation Network (MAIN) Bogota. Source: <http://www.ccap.org/docs/resources/1080/Colombia-case%20study-final.pdf> Last accessed 24/2/19

- Delays with the fare collection concessionaire required starting operations with low-security paper tickets.
- Lower ridership due to parallel competition with incumbent, traditional operators and general poor route reorganization of the traditional bus system.
- Permitting the traditional bus system to remain under a third institution, caused lower ridership levels, and created institutional turf wars and poor coordination.
- Low public transport fares (US \$0.33) and difficulties to raise them. Final fares were 40 percent higher than initially expected, because operators were required to cover part of the infrastructure costs.

7.4. Barranquilla (Transmetro)

Barranquilla is a capital district located near the Caribbean Sea and it is the largest city and port in the northern Caribbean Coast region of Colombia, with a population of 1.68 million and a density of 11,900 people per sq. km, as of 2015⁴⁸.

The project began operations in 2010. The system has trunk, express and feeder services. During the first two years of operation, 29 feeder routes were introduced, connecting to 10 stations. The project involved two bus operator concessions and an AFC concessionaire. Public works (except one terminal) were delivered by the Transmetro SOE, who later took up the functions of a Mass Transit Authority.

Figure 7.5-1: BRT Routes in Barranquilla



Source: Ministry of Transport, Colombia

⁴⁸ Leonardo Canon Rubiano based on official data

Table 7.5-1: Barranquilla Transmetro Data

Indicator	Units	Value
Daily Ridership	passengers	90,000
Revenue, COP	COP M	\$ 59,954
Revenue, 2018 USD M	2018 USD M	\$ 19.8
Trunk line length, KM	KM	13.40
Stations	#	18
Trunk lines	#	2
Fleet	#	73
Speed	Km/h	19
Fare, 2019 USD	2018 USD	\$ 0.76

Source: Leonardo Canon Rubiano based on official data, 2015

7.4.1. Barranquilla - Notable Achievements

PPP Design for terminal infrastructure. Barranquilla was the first BRT project in Colombia to design and contract an infrastructure PPP for the development of a terminal station. The objective of such a contract was to allow the private sector to develop a shopping center and pay for the terminal with a mix of real estate revenues and availability payments.

Expansion of the system. Transmetro gradually and steadily expanded into a larger, open BRT system through the implementation of the ‘pre-BRT’ corridors, deploying dual buses (doors on both sides) to allow operation of services both on and off the busway, thus reducing passenger transfers.

Passenger-friendly technology contributed to ridership increase. In 2017, the introduction of the MOOVIT app allowed passengers to plan their journey to determine real-time location of the bus, expected time of arrival as well as showing road and station closures. Later in 2017, Transmetro launched NFC Technology, a next-generation alternative to the present stored value cards, offering a fare payment function using a smart phone or NFC tag, e.g. on a key ring, and linked to various mobile payment providers. These systems while primarily used for fare collection also allows retail purchases⁴⁹. As a result, the 2017 ridership rose by 3.85 percent.

7.4.2. Barranquilla - Challenges and Issues

Failed infrastructure PPP during implementation. The Soledad Terminal station PPP allowed the concessionaire rights to develop a commercial real estate project above the terminal station and would be repaid via real estate revenues and an availability payment funded by revenues from the BRT operations. The concessionaire did not

⁴⁹ Global Mass Transit Report (2018) Source: <https://www.globalmasstransit.net/archive.php?id=29450> LA31/05/2109

deliver and the SOE was forced to terminate the concession and settle accounts with the concessionaire. Delays in completing terminal stations also contributed to lower-than-expected ridership and revenues, creating financial disequilibrium. Transmetro received national funding to modify the technical fare structure, eliminating fleet scrapping charges (which were included to allow scrapping buses from the traditional system).

7.5. Bucaramanga Metrolinea

7.5.1. Bucaramanga

Bucaramanga is the capital and largest city of the department of Santander, Colombia and represents the fifth-largest economy by GDP in Colombia. In 2015, its metro area population reached 794,000 with a density of 12,300 people per sq.km⁵⁰.

The project began operations in 2010 and gradually introduced feeder routes. Public works were delivered by the Metrolinea SOE, who later took on the function of a mass transit authority. Public works included BRT lanes, stations and three terminal stations, of which one was structured as a PPP. The project incorporated two bus operation concessions and an AFC concessionaire.

Figure 7.6-1: BRT Routes in Bucaramanga

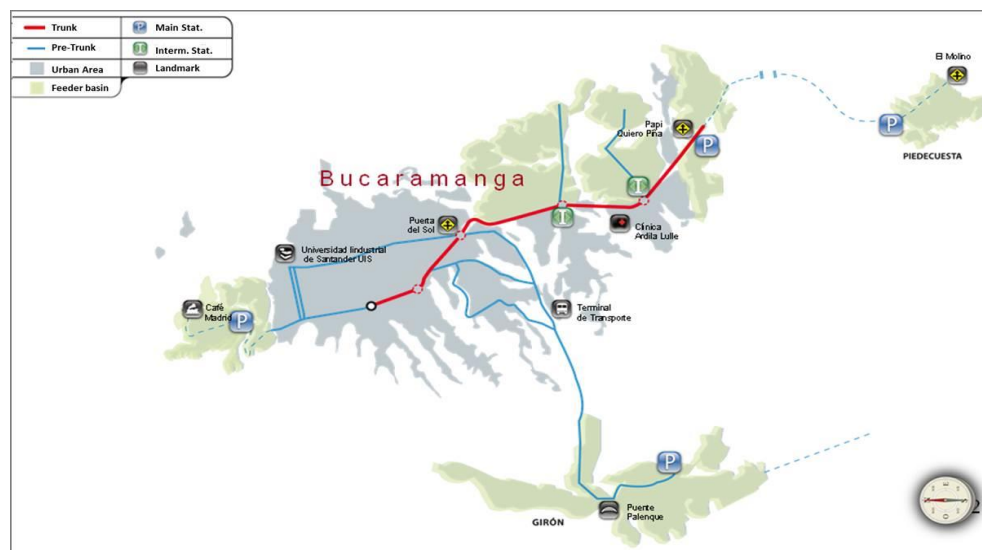

Source: Ministry of Transport, Colombia, 2015

⁵⁰ Leonardo Canon Rubiano based on official data

Table 7.6-1: Metrolinea BRT Data

Indicator	Units	Value
Daily Ridership	passengers	67,000
Revenue, COP	COP M	\$ 43,028
Revenue, 2018 USD M	2018 USD M	\$ 14.2
Trunk line length, KM	KM	8.40
Stations	#	15
Trunk lines	#	2
Fleet	#	39
Speed	km/h	24
Fare	2018 USD	\$ 0.81

Source: Leonardo Canon Rubiano based on official data

7.5.2. Bucaramanga - Notable Achievements

Bucaramanga built a BRT following the BRT design ‘blueprint’ with adequate infrastructure however faced considerable challenges.

PPP design for terminal infrastructure. Following the lead of other cities, Bucaramanga structured an infrastructure PPP to develop one of its terminal stations, namely, Portal de Floridablanca. 11.75 percent of fare revenues were destined to pay the concessionaire.

However, legal challenges on land use driven by complaints by neighbors terminated the Floridablanca Terminal station PPP causing the PPP concessionaire to sue Metrolinea. The PPP had to be scrapped despite a registered advance of nearly 50 percent of works. As at 2018, Metrolinea had not been able to resume construction of this key terminal station.

7.5.3. Bucaramanga - Challenges and Issues

Under-funded terminal project. During the design phase, the construction cost of the North terminal station (Portal del Norte) increased nearly twofold. Without national or local additional funding compensating for the cost overrun, the construction was delayed and had not been delivered as of 2018.

Lack of political support due to lower than expected ridership which weakened its image after operations began. Metrolinea did not receive political support from succeeding mayors, who criticized the system for BRT lanes being empty most of the time (due to low frequencies in off-peak hours) and in some cases they even allowed private car owners to use BRT lanes. Power struggles between the Mayor and the Director of the Metropolitan Area Corporation led to additional tensions between the Mayor, the BRT authority and the operators. These tensions slowed down implementation and affected the commitment to rationalize parallel traditional bus lines, reducing the passenger demand for the BRT.

Lower ridership caused lower than projected revenues. This led to financial weakening of BRT operators, who threatened to cease operations and contest performance-related penalties and fines. The tough financial situation was partially alleviated with loans from National Development Banks to lower financial costs related to fleet acquisition. With the dire financial situation, operators made claims that the fare collector agent was mismanaging data and revenues. Technical audits proved operators wrong and demonstrated the integrity of fare collection data.

7.6. Medellín (Metroplus)

Medellín is the second-largest city in Colombia. Once regarded as a dangerous city, Medellín has been transformed, becoming a vibrant and culturally rich destination. The metropolitan area of Medellín is the second-largest urban agglomeration in Colombia, with a population of 3.35 million and a density of 14,000 people per sq. km in 2015⁵¹.

The BRT began operations in 2011, fully integrated to the Medellín Metro system which had two metro lines operating since 1995. Feeder routes to selected stations have operated since 2013. Metroplus is the only BRT in Colombia fully operated by an SOE, the state-owned Mass Transport Company (EMTVA) which also operates rail, trams and cablecar⁵² It also manages fare collection, financial sustainability, technical know-how and branding.

The BRT Line 1 is a median segregated busway with closed stations representing a strong mass transit presence on the corridor. It has twenty stations, three stations integrated with other lines, and shares sixteen stations with Line 2. Line 2 is a hybrid corridor, sharing much of the busway with Line 1 and operating complementary to the Metro Rail to form an integrated network.

Figure 7.7-1: BRT Network in Medellín

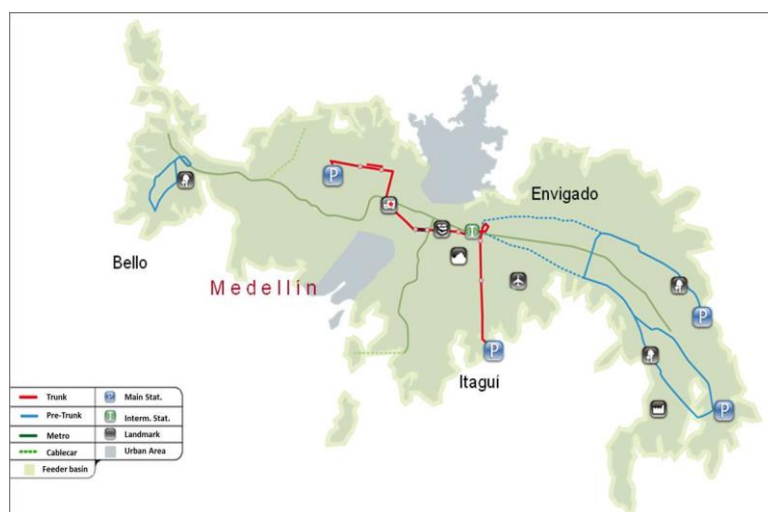

Source: Ministry of Transport, Colombia

⁵¹ Leonardo Canon Rubiano based on official data

⁵² <https://es.wikipedia.org/wiki/Metropl%C3%BA>

Table 7.7-1: Medellín BRT Data

Indicator	Units	Value
Daily Ridership	passengers	140,000
Revenue, COP	COP M	\$ 43,028
Revenue, 2018 USD M	2018 USD M	\$ 14.2
Trunk line length, KM	KM	12.50
Stations	#	20
Trunk lines	#	1
Fleet	#	67.0
Speed	km/hr	22
Fare, 2019 USD	2018 USD	\$ 0.84

Source: Leonardo Canon Rubiano based on official data, 2015

7.6.1. Medellín - Notable Achievements

Implementation went well but faced some minor delays and cost overruns. Safeguards and social consultations are best practice in Colombia.

ETMVA Metro fully integrated BRT into its institutional, technical and commercial business model, making BRT part of Medellín's integrated mass transit system, consisting of two rail lines, four Metrocable lines, two Metroplús elongated bus lines stations, and one Tranvía tramcar line with 11 stations; and a feeder bus network that connects Metro stations with neighborhoods all over the city. Unsuccessful attempts to arrange a PPP opened a window of opportunity for Metro to take control of the operation.

EMTVA Metro is successful in its financial management of the BRT. Medellín is the only BRT in Colombia that has not publicly reported financial imbalances in operating its transport system. ETMVA was also able to transfer the positive image of the rail system to the BRT and according to surveys, achieved some of Colombia's highest marks in user satisfaction ratings.

Figure 7.7-2: Medellín Metro**Figure 7.7-3: Tranvía tramcar line T-A**

Figure 7.7-4: Tranvia Tramcar Line



Figure 7.7-5: Civica Integrates Fare system

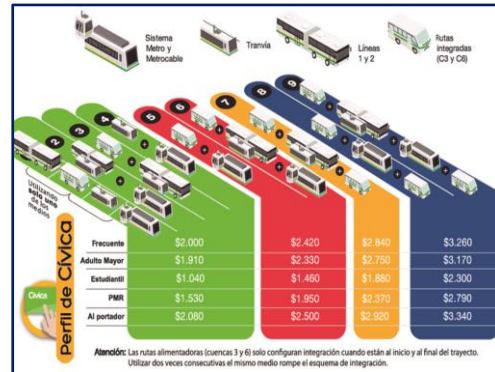

Source: <https://medellinliving.com/medellin-metro/>

7.6.2. Medellín - Challenges and Issues

Non-integration with the local bus network and opposition to expansion. Despite Metro's successful management of the mass transit system (including cablecars, tram, rail and BRT), *the municipal government is still in charge of the local bus network, preventing full integration with the Metro-managed transit network.* In addition, local high-income residents have fiercely opposed its expansion, resulting in suspended (now cancelled) civil works.

Energy propulsion options. There was a lot of discussion about the type of fuel that should be used for the operation of the buses⁵³ between options of electric buses, diesel, or gas. Finally, it was decided to use gas-powered buses, according to a brief study. Subsequently, thinking has turned to electric powered vehicles as more suitable to the topography (more torque in hill sectors) and further studies have confirmed the technical credentials of electric buses and their low emissions. Consequently, in 2017 electric buses were trialed resulting in an order for 64 electric buses to be introduced in 2019.

Weakened role of the City in public transport planning and management. The management of BRT has been handed over to the operator, by the fact that the Metro SOE took over BRT operations. Metroplus SOE, originally created with a vision to deliver infrastructure and manage BRT operations (as it happens in other Colombian cities), is now solely an infrastructure delivery unit for BRT, limiting its role in public transport planning and management.

7.7. Cartagena (TransCaribe)

The city of Cartagena, located on the northern coast of Colombia in the Caribbean Coast Region is the fifth-largest city in Colombia and also the fifth-largest urban area in the country. Its metropolitan population is at 1.12 million in 2015, with a density of

⁵³ <https://es.wikipedia.org/wiki/Metropl%C3%BAs#Flota>

12,900 people per sq. km⁵⁴. The TransCaribe BRT system⁵⁵ began operations in 2016 and is part of what is referred to as the Integrated Mass Transportation System of Cartagena (SITM). The system is designed to cover its operational costs by bus fare, and bus operators are paid to provide services. Automatic fare adjustments are made to cover increase in costs.

Figure 7.8-1: BRT Network in Cartagena

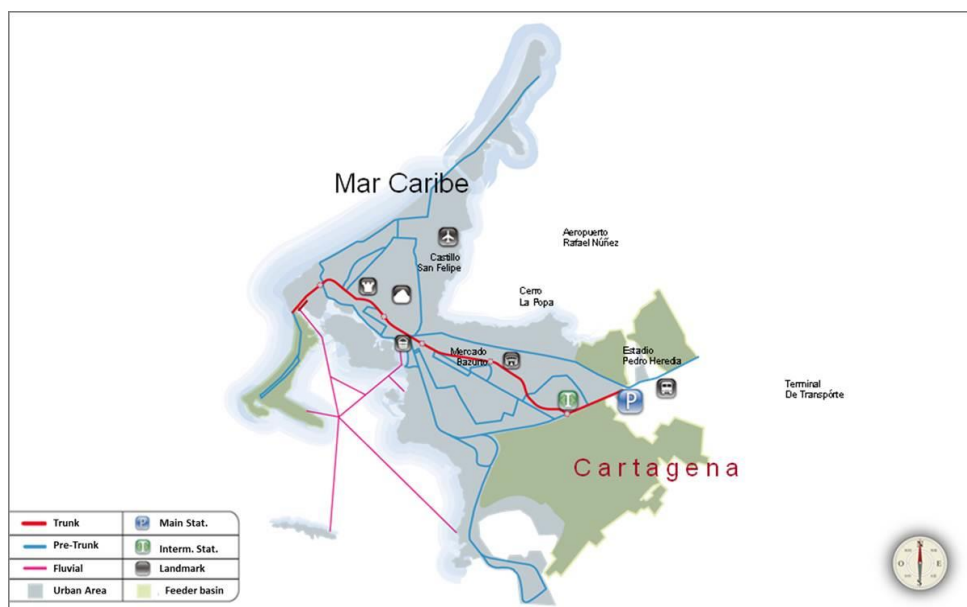

Source: Ministry of Transport, Colombia

Table 7.8-1: TransCaribe BRT Data

Indicator	Units	Value
Daily Ridership	passengers	90,000
Revenue, COP	COP M	\$ 43,028
Revenue, 2018 USD M	2018 USD M	\$ 14.2
Trunk line length, KM	KM	15.03
Stations	#	18
Trunk lines	#	1
Fleet	#	120
Speed	Km/h	26
Fare	2018 USD	\$ 0.83

Source: Leonardo Canon Rubiano based on official data, 2015

⁵⁴ Leonardo Canon Rubiano based on official data

⁵⁵ <https://www.cccartagena.org.co/es/proyectos/proyectos-regionales/sistema-integrado-de-transporte-masivo-transcaribe> LA14/05/2019

Figure 7.8-2: BRT station - Accessible and Air-Conditioned

Source: TransCaribe

Figure 7.8-3: Pre-Troncal Bus

Source: ITDP

7.7.1. Cartagena - Notable Achievements

Construction was successful in a challenging environment. The corridor works included a complete renovation of the roadway to improve the flow of parallel traffic, but Cartagena is a UNESCO World Heritage city and construction works bordered its heritage sites.

Innovative financing mechanisms allowed coupling of experienced bus operators (sponsors) with international, non-traditional financiers, including IFC, and national development banks.

System performance showed the commercial speed of the busway had risen to 24.9 km/h, compared to 11–21 km/h in the parallel mixed-traffic lanes (also upgraded) used by conventional buses⁵⁶. Point-to-point travel times by public transport fell by 37 percent to 43 minutes (from 68 minutes).

7.7.2. Cartagena - Challenges and Issues

Difficulty in expanding the system despite good performance. The last Colombian BRT to enter operations, Transcaribe's infrastructure faced numerous user-perception issues related to infrastructure designs, safeguards, resettlement, and, lastly, lack of confidence of the private sector and financiers to bid for bus operations concessions. This led to one SOE operator to be appointed alongside two PPP bus concessionaires, and a PPP fare collector. Procurement issues, complicated land acquisition and resettlement problems further contributed to construction delays.

7.8. Summary of Colombia Cities (Excluding Bogotá)

A national program provided mass transit financing to multiple cities and created an urban transport culture. This program established a system where the national government helped with planning and orientation plus financing (70 percent), and local governments responded with interest and commitment to develop the projects, along with their share of financing (30 percent). **Collaboration between the national and local governments was crucial to the success of mass transit system development in Colombia.** Even more importantly, through the implementation of BRT, the NUTP developed local

⁵⁶ Performed by Cartagena Cómo Vamos, (*Cartagena – how are we doing?*) a non-governmental organisation

capacity and experience in public transport planning, operations, construction management, and in the management of the informal sector. This is a valuable outcome for all participating cities.

The implementation experience showed that on average, cost overruns (except for Bogotá) were at 23 percent mainly due to expansions in infrastructure and in the geographical footprint. Unexpected problems included larger than expected work to restructure utility networks and greater quantities of works (Bucaramanga and Medellín), topographical and other design errors and delays in securing the Right of Way (ROW) (Cartagena) and land acquisition delays and additional works to address project interference with utility networks (Barranquilla). The MOT estimated that the value of contract additions was approximately 10 percent of the total contract value as of 2010.

7.9. Case Analysis: Lessons Learned

7.9.1. Notable Achievements for Colombia's 6 cities

- Under the NUTP mandate, institutional changes created SOEs to deliver and run BRT systems, providing an adequate distribution of responsibilities, incentives and risks in project development and operation. The public sector is in charge of the infrastructure, and the planning, supervising and controlling of operations, while the private sector is in charge of buses and fare collection acquisition and operation.
- It created a political emphasis (and funding availability) that was offered to cities prompting them to undertake a large project that otherwise would have been out of their reach. National policy support created practices that supported local strategic mass transit interventions⁵⁷, making a positive impact on local urban transport.
- Its 'macro-level' intervention created a window of opportunity for cities, setting the stage for their local 'meso-level' planning (social-technical), and finally into the 'niche-level'. The meso and niche levels is where cities can work from the grassroots upward to define needs and solutions within the macro-level initiative (Mejía-Dugand et al. 2013). This level of planning in the local context gave rise to examples such as the 'pre-troncal' services in Barranquilla, Medellín and Cartagena, and prompted Medellín to integrate the BRT into the Metro system and saw Cartagena engage a public bus operator alongside the PPP operators. None of these initiatives were part of the national plan.
- **Good integration of BRT into the road infrastructure.** All cities took an integrated corridor improvement approach, upgrading the BRT corridors from sidewalk to sidewalk, including parking management, mixed traffic lanes, busways, and public space, lifting the travel experience of all users.

⁵⁷ Medium-sized cities BRTs – Technical Assistance – Colombia, Bianca Biachi Alves and Alejandro Hoyos Guerrero, World Bank, 2019.

7.9.2. Challenges and Issues for Colombia's 6 cities

Nearly all systems experienced financial uncertainty due to lower than expected ridership, and a high cost of investment and operations reflective of the additional cost of formalization (fleet maintenance, payment of tax, and labor rules).

These intermediate cities were under the same constraints on subsidy support as Bogotá, (Law 86 of 1989, Article 14) operating on the paradigm of full cost recovery through fares. As stated earlier, only Medellín was able to avoid financial difficulties due to its integration into ETMVA Metro.

Ridership was consistently below forecasts, largely attributed to increased Generalized Cost of Transport (GCT)⁵⁸ vs. decreased service levels, as well as the lack of integration with other public transport (thus lacking ability to transfer easily)⁵⁹. In Bucaramanga, low ridership has been responsible for declining political support.

7.9.3. Observations

Two important observations are made, being:

- **The costs of high-end BRT may not be warranted given the eventual ridership.** The infrastructure, technology, fleet renovation, and major restructure of operators etc. adds cost that affected the cost/fare ratios, impacting on low-income groups. The lesson is that the level of investment should be reflective of the market, so it remains affordable.
- **Overall public transport ridership may suffer if BRT does not meet market needs.** Replacing diverse traditional routes with a corridor-centric BRT did not sufficiently consider the determinants of demand and the GCT, resulting in an overall decrease in passenger travel demand. A parallel increase in competition from mototaxis (as passengers looked for alternatives) may have also played a role⁶⁰. *This highlights the importance of working with the traditional bus network to build a mutually reinforcing network and provide a holistic travel product to the passengers.*

⁵⁸ *Generalized Cost of Transport* takes into account the shadow costs, for example: discomfort, travel and waiting time, and the physical demand of travel, as well as opportunity costs, being (in terms of time and budget) alternative benefits foregone.

⁵⁹ Medium-sized cities BRTs – Technical Assistance – Colombia, Bianca Biachi Alves and Alejandro Hoyos Guerrero, World Bank, 2019.

⁶⁰ Gomez-Lobo A. (2019) BRT Reforms in Colombia : an ex-poste evaluation

8. Dar es Salaam, Tanzania



Among the African projects reviewed, Dar es Salaam was the most influenced by the Colombian BRT model. With a planned network of six corridors, the city is taking a phased approach under a policy commitment to “support Tanzania’s economic growth by providing enhanced transport facilities that are reliable and cost effective”. Phase I achieved a high user satisfaction and a significant reduction in passenger travel times from 62 to 28 minutes. Some operational problems included long waiting times and overcrowding due to insufficient fleet.

The BRT infrastructure is of high quality and the system has inspired other SSA cities looking for ways to transform urban mobility. Implementation was challenging, as the system sat idle until bus operation contracts and fleet acquisition took place. Political pressure to launch pushed the agency into an ill-conceived Interim Service Provision (ISP) with a local bus operator which has caused ongoing difficulties. The DART agency is working to transition from this current arrangement and take control of fare collection and revenue while continuing to expand the network.



8.1. City and Urban Transport Context

Dar es Salaam is the largest city, industrial center and major port of Tanzania. It is the most populous city in Tanzania with a population of 4.36 million (2012) growing at an average rate of 5.6 percent. The metropolitan population is expected to reach 5.12 million by 2020. It is also the most densely populated region with 3,133 people per square kilometer⁶¹.

Population growth and rapid motorization led to worsening congestion on Dar es Salaam’s main roads, with a motorization rate of 30 vehicles per 1,000 of population in mid-2000s), directly impacting the city’s competitiveness as Tanzania’s economic powerhouse.

Public transport in Dar es Salaam largely consisted of privately-operated mini/mid-size buses (daladala) of which there are approximately 7,000 in service, aggravating an already congested road system. Parallel to BRT implementation⁶², more city buses entered service on regular daladala routes.

The Government of Tanzania adopted a six-corridor BRT network, with a BRT design following the model of Latin America cities, envisaging a high capacity system with lower operating costs and flexibility to attend to demand and to be sustainable over

⁶¹ Population Distribution by Administrative Units, United Republic of Tanzania, 2013 Archived May 2, 2013, at the Wayback Machine.

⁶² The introduction of large buses on the BRT showed that these were a profitable venture and more operators introduced large buses.

time with no operational subsidy. To achieve financial sustainability, the DART Agency was established as a commercial entity.

8.2. Project Development Objectives and Schedule

The Project Development Objective (PDO) was to “support Tanzania’s economic growth by providing enhanced transport facilities that are reliable and cost effective”.

Project implementation took eight years starting in 2008 and BRT operations launched in 2015. The project was extended twice from the original completion date of December 2011 to December 2014 and then December 2016. Additional financing was provided by the World Bank to cover BRT cost overruns.

8.3. Case Analysis: BRT System Design

The Morogoro Corridor, known as BRT Phase 1, was the first BRT corridor under implementation and operations and has faced ongoing operational and institutional challenges. Serious concerns regarding BRT line capacity are being examined.

Figure 8.3-1: Phase 1 BRT corridor

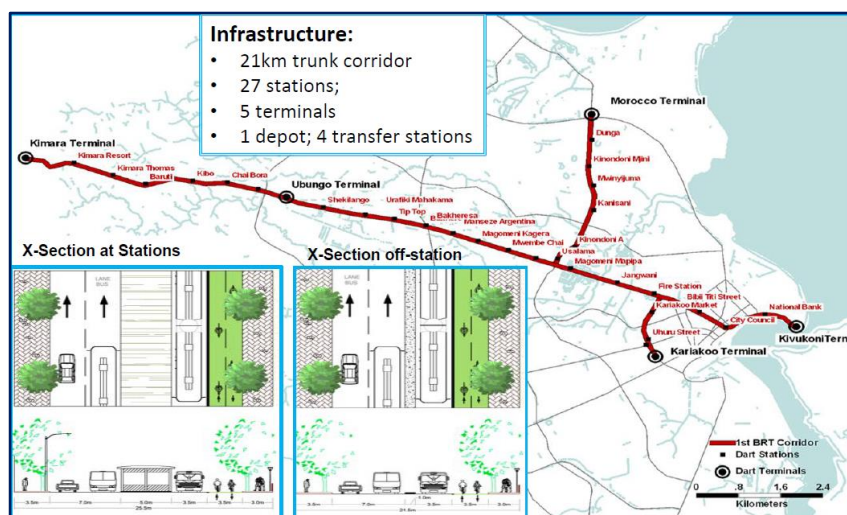

Source: Yonas Eliesikia Mchomvu, World Bank

The design features a standard trunk and feeder system with segregated and exclusive bus lanes located in the median of arterial roads, serving high-platform stations, and achieving an average design speed over 20 kilometers per hour. The transit mall serving as a ‘downtown pedestrian zone’ in the city center is an 11-metre wide bus-only section. Cyclists are permitted to access the BRT corridor in this section, and yield to approaching buses, but there are no special treatments for pedestrians, and motorbikes frequently invade the space. Tight and unsafe bus turning radius are observed on this CBD section.

The fare collection is pre-board fare collection, with no integration discount for trunk and feeder, charging a ‘flat fare’ of TZ shillings 650 (28 cents) for trunk, 400 TZs for feeder although the actual approved tariff for a combined trip is TZ shillings 800. A

passenger on BRT who transfers from a daladala would effectively pay double the fare of doing a similar trip in a daladala.

No traffic signal management system presently operates and buses often experience bunching especially at inner city stations. Despite plans for a high capacity system, the passenger carrying capacity is constrained by inner city bottlenecks and less than expected service levels, causing overcrowding.

Figure 8.3-1 & 8.3-2 Inner City Bus Congestion



Source: Frits Olyslagers 2017

Figure 8.3-2: Bus Station



Source: Wenyu Jia, World Bank

Figure 8.3-4 Overcrowding on DART BRT (2018)



Source: Yonas Eliesikia Mchomvu, World Bank

8.4. Case Analysis: Operations Management

The Dar Rapid Transit Agency (DART) is responsible for overall management, regulation, planning, and marketing under a PPP model, and private operators carrying out operations and maintenance. The Tanzania National Roads Agency (TANROADS) is responsible for implementing BRT infrastructure, and the Surface and Marine Transport Regulatory Authority (SUMATRA) is the regulator setting fares. At planning stage for Phase I, the PPP structure was envisioned with individual private contractors reporting directly to DART as follows:

- A Fare Collector responsible for daily fare collection, maintenance of the fare infrastructure and software;
- Two Bus Operators responsible for acquisition, operation, and maintenance of buses along specified trunk and feeder routes;

- A Fund Manager responsible for financial management and reporting, payments to the bus operators, fare collector, DART agency, the fund manager, and investment into the contingency fund.

In reality, these plans were not realized as international bus operators were cautious with the market, citing too many uncertainties, namely MOF not willing to commit to bus-km payments because of the possible fiscal impact and also that the plans did not guarantee a role for daladala operators. So, with the infrastructure largely completed, and not having secured a bus operator or fare collection company, DART came under intense political pressure to get the system running.

Finally, the impasse was overcome when UDA (a former government bus operator since privatized), signed an exclusive deal with the two daladala associations and made an unsolicited proposal to government based on this new consortium (UDART) collecting user revenues and paying a small access fee to government; becoming the interim service provider (ISP). Newspaper reporting at the time indicated that DART employed a strategy to empower UDART to “*build the capacity to ultimately manage to run the multi-million project*” with whom International bidders “*would want to form a joint venture with*”⁶³.

The ISP contract, while bringing local operators together to jump start BRT operations, had its flaws including a short contract period (2 years) requiring UDART to repay buses in 2 years, causing financial difficulties and survival behavior (such as cutting services with lower demand). Some may argue that this arrangement assists DART, in that they do not have to carry the revenue risk, but the tradeoffs are that DART has little operational control, and quality of service is often compromised.

Further exacerbating the problem was that UDART promptly seized the fare collection task with the purchase of electronic fare equipment, forcing DART – less than willingly, to accommodate this, as the government continued to be a minority (49 percent) shareholder of UDA, creating a potential issue for enforcing compliance. Thus, UDART acquired both the bus fleet and the fare collection system, at a total estimated investment of \$40 million, being \$6M for the fare collection system and \$34M for the bus fleet which includes 39 articulated buses and 101 rigid 12-meter buses.

UDART managing the fare collection and taking revenue risks, allowed them to exploit the power imbalance and dictate service levels according to their own resource allocation and business decisions, leaving the DART agency in a weak position. Recently, UDART attempted to block the procurement of a competitor arguing ‘*breach of the contract giving them exclusive rights to operate rapid transit buses in the city*’⁶⁴. Currently, DART is moving toward securing a second operator for BRT Phase 1 and changing the structure by placing the fare collector under its direct supervision.

⁶³ The Citizen 23/11/15 quoting M. Kuganda Infrastructure Manager DART Agency. Source: <https://www.thecitizen.co.tz/News/1840340-2968240-xr45mdz/index.html> last accessed: 24/2/19

⁶⁴ The Citizen Source: <https://www.thecitizen.co.tz/News/High-Court-halts-search-for-second-Dart-bus-operator/1840340-3789404-tyta1nz/index.html>

8.5. Case Analysis: Impacts of DART BRT on Paratransit

The proposed methodology in BRT Phase I was to resettle daladala to other routes, or formalize them into the BRT business, or compensate them out of the business. However, the impact of displacement would amount to one BRT bus replacing 10 minibuses which potentially had a large impact on employment. Resettling operators to other routes proved difficult, as was keeping the promise to absorb the workforce into the BRT due to the complexity of the direct and indirect ancillary employment opportunities around paratransit such as cleaning and repairs.

Under political pressure to resolve the daladala displacement issue, the government offered public funds to promote the incorporation of daladala owners into DART when it announced that it would purchase all old daladala six months before DART was due to start operations⁶⁵, and those funds could be used by owners to purchase shares in the new BRT. However, the bus owners' association turned down the offer, as the compensation that could reasonably be offered for older vehicles was expected to be low⁶⁶. Bus operators were seeking opportunity to set up collective companies but found little by way of financial support, and they were wary of not making a profit and being cheated (Rizzo p266-267)⁶⁷. The expectation for them to compete with foreign investors left them disempowered. Eventually, the ISP contract offered a way where the daladala associations were nominally involved.

The difficulties seem to stem from lack of a clear plan on how daladala operators were to be involved, despite there being a great will to make it happen (Atheron 2009:21)⁶⁸. This issue will arise during future phases, and needs to be addressed.

8.6. Case Analysis: Lessons Learned

DART faces ongoing reputational challenges on Phase 1 namely: deterioration of operations (long ticketing queues, unreliability of services, high driver turnover); inadequate DART capacity; hesitation in securing new operator contracts, inadequate communication with the public, and seasonal flooding at the only bus depot which severely impacted on services.

Other key implementation and operations lessons drawn from Phase 1 are:

- Lack of critical analysis on why Dar es Salaam encountered different challenges, despite sound planning initially. In the promotion of BRT, major reform areas and on-ground realities were glossed over (such as, the challenges of industry restructuring and securing competent bus operators, fare collection technology, developing competent institutions) giving the impression that most of this could simply be contracted out, and that the outstanding merits of the project would attract universal support from all sides.

⁶⁵ Abduel Elinaza, 'Dar to remove old daladala', Daily News, 25 September 2012.

⁶⁶ Rizzo, M. (2015) Interview, Sabri Mabrouk, 13 February 2014.

⁶⁷ Rizzo, M. (2017) Taken for a Ride. *Critical Frontiers of Theory, Research, and Policy in International Development Studies*.

⁶⁸ Ahferom MT. (2009) MSc. Degree. Thesis: Sustainability Assessment of a Bus Rapid Transit (BRT) System: The Case of Dar es Salaam, Tanzania. Lund University

- The lack of a sound business model, being a key reason why competent bus operators shied away⁶⁹.
- Idealism overcoming pragmatism, based on LAC success stories and optimism that Dar es Salaam was building the first BRT in East Africa based on the LAC model. Where resistance occurred, it was categorized as a '*lack of appreciation of the BRT system*' (Kamulala 2010)⁷⁰. This idealism, combined with the deficiency of operational experience and capacity compared to LAC cities, impacted Phase 1's operations management.
- Being realistic about BRT capacity. Despite the promotion of BRT carrying up to 45,000 passengers phpd (in the case of TransMilenio), DART reported bus congestion on the Phase 1 BRT corridor in 2017 when buses were carrying according to the operational plan, less than 7,000 passengers into the CBD⁷¹.
- Lack of institutional readiness, uncertainty over the business model and risk assignment, posed difficult implementation challenges. Despite the DART adopting a standard 'boilerplate' km-based contract, the government was cautious on fiscal risks involved and investors were uncertain on payment guarantee. *The lesson is that more emphasis needs to be placed on getting the business model right and managing risk.*
- Lack of qualified local private sector for civil works caused substantial delays with the civil works and cost overruns. The first international contractor withdrew over concerns it had underpriced their bid. Retendering resulted in a much higher cost of civil works with a more competent contractor.
- Incomplete design documents by the planning consultants with insufficient drawings and detail for key areas and a significant number of unmapped utilities, esp. water and sewerage for relocations. This led to delays during construction as the contractor sought contract revisions from TANROADS the implementing agency. The lesson is that an independent review of designs needs to be undertaken prior to construction supervision.

⁶⁹ As cited by one operator in discussing Dar es Salaam with the author.

⁷⁰ Kamulala (2010) Daladala Grievance Plan

⁷¹ Buses (operating 45 buses per hour) are scheduled on the section every 80 seconds and carrying approximately 150 passengers per bus.

9. Hanoi, Vietnam



Vietnam's capital city of Hanoi, is the first city to implement BRT as a mass transit system in a city where traffic is dominated by motorcycles, making it a most testing environment in which to introduce a BRT. Despite its difficulties over a long implementation period, Hanoi's BRT is a good demonstration of a pilot BRT system that can be replicated on other corridors. It has given the city the confidence in improving its bus network which after a decade of growth was recently trending downwards in ridership. Service enhancements are still needed, such as redesigning the bus network to better integrate the BRT.

The BRT reduced travel time by about 10-15 percent from the current 50-minutes along the congested corridor and achieved high user satisfaction, with just over half the BRT passengers being former motorcycle users. The BRT is an important first step towards transforming this rapidly growing city's mobility.

Forward challenges are to develop ridership from the low base (though it continues to rise), implement a ticketing system and to maintain the priority of BRT lanes. This will require a firm commitment to the improvement of public transport and produce real changes in mobility choices, which may take some time⁷².



9.1. City and Urban Transport Context

Hanoi is Vietnam's capital and second largest city by population, located in the northern region of Vietnam, on the Red River delta, nearly 90 km away from the coastal area. It has a population of approximately 7.58 million (2018) and an estimated population density of 2,300 people per square kilometer⁷³. Industrial production in Hanoi experienced a rapid boom since the 1990s, adding numerous large-scale industrial parks and industrial clusters.

Hanoi experienced a fifteen-fold increase in mainly motorcycles but also cars between 1990 and 2005, operating on a sparse road network. Despite a twenty-fold increase in bus passengers, public transport accounted for only 10 percent of total trips.

To address this, in 2008 Decision No. 90 by the Prime Minister authorized the Vietnamese government and the local authorities to implement a comprehensive Public Transportation System composed of Metro lines and dedicated bus lanes in

⁷² Source: Jung en Jungeun Oh Senior Transport Economist WB

<https://www.linkedin.com/pulse/first-bus-rapid-transit-vietnam-opens-service-hanoi-jen-jungeun-oh>

⁷³ <http://worldpopulationreview.com/world-cities/hanoi-population/> Last accessed 13/07/2019

Hanoi. This plan was orientated towards a sustainable urban transport concept to improve traffic conditions and reduce air pollution⁷⁴.

Hanoi has two notable features:

1) Despite the increase in motorcycle use, the heavy traffic of Hanoi is still flowing, thanks to the efficiency of motorcycles where they represent 80 percent of road users, but use only 62 percent of road space⁷⁵. Energy efficiency for motorcycles is also highly favorable compared to cars. Passenger comfort and safety aside, motorcycles are a tough sector for a BRT system to compete with.

2) The remarkable growth of the government-subsidized bus system in Hanoi. In the 1980s, buses carried 50 million passengers per year, satisfying 20 percent of the travel needs of people in that period. Under *Đổi Mới* (1986) a removal of subsidy caused patronage decline to 3 mill. passengers per year, catalyzing the growth in motorbikes. In 1993 to 2001 the city began to re-subsidize, but bus ridership grew very slowly, so the city established the Hanoi Bus State-owned Enterprise (TRANSERCO), to focus on comprehensive renovation of bus operations, streamlining the bus route network, and applying centralized management. In 2015 TRANSERCO operated 1,208 vehicles and carried 431 million passengers in 2015 (increasing from 15 million in 2001).

9.2. Project Development Objectives and Schedule

The objectives of the Project were to: (i) increase urban mobility in targeted areas of Hanoi through increased use of public transport in selected traffic corridors and reduce travel time between the center and the west and northwest sections of Hanoi; and (ii) promote more environmentally sustainable transport modes and urban development plans for Hanoi.

The total period of the implementation for the project was nine years from 2007. The original plan for the implementation was only 6 years to close the project on 31 December 2013, but with three restructurings in 2013, 2015 and 2016, it extended the close date to 31 December 2016. During the restructuring, Line 1 was shortened to terminate at Kim Ma terminal (3.8 km of BRT routes cancelled) due to concerns on BRT operability in mixed traffic in the city center. These changes had a negative impact on the eventual ridership. Figure 9.2-1 shows the route changes.

Project delays and the difficulties surrounding a procurement dispute (and subsequent cancellation) of the BRT electronic ticketing system caused the city to lose confidence in the project and found itself in a predicament as how to complete the project. The problems were finally overcome and the project launched on 1 January 2017, where

⁷⁴ Musil, C. Molt, C. (2010- conference Paper) 'Building a Public Transportation System in Hanoi: Between emergency and constraints, Source: https://www.academia.edu/12278774/Building_a_Public_Transportation_System_in_Hanoi_Between_emergency_and_constraints Last accessed 22/03/2020

⁷⁵ From survey conducted in 2008 by TRAMOC as part of the Ecotrans project.

users were finally able to appreciate how the system operates, and passengers expressed satisfaction with the service quality and travel times.

Figure 9.2-1: Map of Planned BRT lines

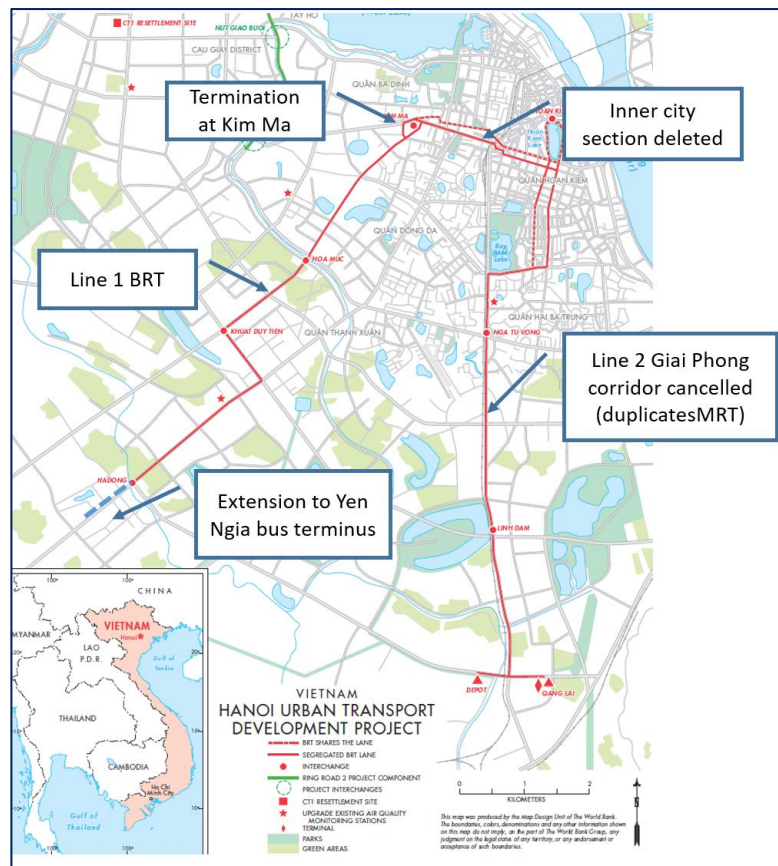

Source: HUTPMU

9.3. Case Analysis: BRT System Design

Hanoi's design of BRT followed the classic segregated busway with median stations on a single corridor. As such it is a highly recognizable mass transit infrastructure with good facilities for managing passengers boarding and alighting. Access to stations in some locations need to be improved. BRT was designed as a closed system; but given its lower than expected ridership, it could benefit from better integration with the bus network.

9.3.1. Positive Design Features

Flexibility of design suitable for replication. The design of the Hanoi BRT system makes it relatively easy to replicate on other major corridors, especially if it is approached with some flexibility in mind. While the city currently has a transport master plan which prioritizes mass public transport, there is some evaluation underway on how best to develop bus priority lanes.

Given the experience of BRT in the Hanoi context, the decision to change the original BRT alignment to a Metro system was a correct one. Selecting a lower capacity corridor

for BRT is acceptable in this case because any improvement in bus infrastructure is worthwhile if it increases the profile of public transport, improves quality and efficiency of bus travel speeds and ultimately becomes part of an integrated network with the Metro.

9.3.2. Drawbacks of the Design

Lack of enforcement on exclusive lanes. Prior to completion, the DOT decided not to install hard barriers, fearing backlash from motorists, as the decade long BRT build had seen traffic congestion significantly worsen. In practice this fear was proven to be largely unfounded, as despite some careless encroachment (and some deliberate illegal use during wet weather and extreme congestion situations), the BRT lanes were (at least initially) more or less respected, which encouraged the HPC to install more hard barriers to protect the BRT lanes. Lack of a hard barrier also caused stress for bus drivers, as motorcycles continuously threatened to encroach in the path of the bus.

While the Traffic Police carry responsibility for enforcement using cameras and can penalize violators with a heavy fine equivalent of \$40, their natural priority is to keep traffic moving, so the enforcement is sometimes lax.

Lack of integration with the general bus network. As a single corridor, access for passengers is mainly walk-up. More attention is needed to improve these access paths and the road crossings. In a relatively low-capacity system, allowing regular (door-adapted) buses to enter the busway could significantly improve network efficiency and give BRT a wider footprint in the community, and there is nothing to prevent the system from being modified accordingly.

Lack of consistent 'bus priority' along the route. The benefits of BRT are compromised at various 'choke points' such as intersections, inner city streets, or flyovers, where they are not given priority and then required to compete with other traffic. The system will not be able to deliver the service level sufficient to win passengers if buses are stuck in traffic. These traffic 'choke points' also impact on bus schedules which in turn, affects reliability of services.

The above-mentioned issues of integration, access and operational configurations are not insurmountable. While good planning at the start is important, potential problems are not always evident in planning, and many city's experiences demonstrate the need to adapt to on-ground realities once the system is in operation.

9.4. Case Analysis: Operations Management

While the initial plan was to tender operations to private sector bus operators, it soon became clear during the implementation that the private sector in this market were weak. TRANSERCO, the state-owned enterprise stood out as a strong player as it operates buses along 100 routes, making it the best contender to get BRT operational. This was agreed to at the first restructuring, where TRANSERCO was given a five-year operations contract, setting aside the PAD requirement for open tender for private

operators. This was also to reduce delays and uncertainty in securing an operator. This proved to be a prudent decision as TRANSERCO has proven to be a capable entity.

9.5. Case Analysis: Government Commitment

Despite strong commitment by HPC, especially during the two restructurings in 2013 and 2015, turnover in high-level politicians and decision-makers in the city over time led to a loss of committed supporters, causing a wavering in confidence in the BRT system over the course of its implementation. In no small way, the lack of an operational plan (and feasibility) at the commencement of the project, caused uncertainty in decision-making and an underlying lack of confidence throughout the project.

To improve the situation, a study tour to some international examples of BRT (Curitiba and Bogotá) was arranged to familiarize Hanoi's leaders on quality BRT services, however it actually made them more risk aware, as they came to appreciate how the unique characteristics of Hanoi and its selected corridor differed from these 'model' BRT cities.

9.6. Case Analysis: Institutional Arrangement

The project design clearly prioritized capacity building in transport and planning/ implementing institutions for Hanoi, with a key PDO indicator, being the establishment of a public transport authority (PTA) to coordinate the project at a high level.

However, by project end, the PTA was not established, and the resultant multi-pronged responsibility caused coordination problems, leading to fragmented decision-making and diluted commitment to the project. Fragmentation still persists in that the mass transit projects are housed separately, with the DOT establishing the Hanoi Transport Management and Operation Center (TRAMOC) to plan, implement conventional bus and BRT, while the HPC (city level) is responsible for the Metro, and the Ministry of Transport (national level) is managing the LRT project. The lack of a proper coordination mechanism will make future intermodal integration problematic, leading to inefficiencies in route and service planning, infrastructure design, ticketing and the passenger information system.

9.7. Case Analysis: Lessons Learned

9.7.1. Hanoi - Notable Achievements

- **The Hanoi BRT delivers on the objective of a safer and more respectful mode of travel and building up market acceptance to grow ridership and improve performance.** This is demonstrated by the data showing 51 percent of the BRT riders would have used a personal motorized vehicle (including private car, taxi, motorcycle, or motorcycle taxi) for their trips prior to BRT. More recently, user satisfaction is good, and the

BRT represents one of the most used bus corridors and peak loads are high⁷⁶. The BRT also improved the safety in the corridor—no fatalities and injuries have been reported in the first year’s operation.

- **Local pragmatic solutions can be devised to meet challenges.** Despite the original PAD agreement requiring two private operators to participate in the operation of the BRT system through open tender, the 2013 restructuring made way for TRANSERCO to operate the system for the initial 5 years. This was a good decision, given the political embarrassment of having completed the BRT infrastructure but not having the operational aspects managed. The operator TRANSERCO, being a SOE is experienced and was able to implement services expediently. It also compensates for the inexperience of TRAMOC in managing the network.

9.7.2. Hanoi - Challenges and Issues

The project faced many difficulties and challenges, and it is difficult to determine precisely what were the causes and effects. Here we raise some key issues.

- **Ridership was below target** due to significant compromises in design and implementation to get the first BRT into operation. However, ridership is steadily growing and the system can be built upon, say with better integration of other bus routes, to improve passenger numbers.
- **Long project delays** caused considerable difficulties, affecting political support, commitment and confidence, which hindered decision-making.
- **Design failures due to the lack of a detailed operational plan.** It appears that planners decided on a standard BRT design based on certain assumptions that had serious ramifications for the future, for example, locating stations close to intersections without finalizing the intersection management plan. The lack of a clear operational plan affected confidence in decision-making throughout the project.
- **Compromise on BRT exclusivity and traffic priority.** Not maintaining the exclusive busway lane will have effects on ridership, which could threaten support for BRT. Small compromises can lead to a spiraling effect where declining standards erode the confidence in the system. The following Figures 9.7-1 to 9.7-6 show observed problems.
- **Hanoi’s BRT has drawn criticism** for not complying to the ‘Gold Standard’ of BRT design. Such criticism is unwarranted because prescriptive ‘BRT standards’ do not take into account the specific requirements of the city. Any comparison between a full-scale BRT and Hanoi’s BRT is immaterial as road widths and operating environment can differ greatly between cities.

⁷⁶ TTL Interview, 2019

Figure 9.7-1: Need for hard barrier



Occupancy of the BRT lane is commonplace, and despite the BRT bus horn-blowing, these violators are unwilling to move aside. While the painted line 'soft' barrier generally separates traffic from the bus lane, the BRT driver is constantly under stress, threatened by traffic intruding on the bus lane.

Figure 9.7-2: BRT lane invasion



The painted barriers need constant enforcement. When traffic gets heavy, such as in wet weather motorists appear to see it as OK to take over the BRT lane. The lack of left turn management at intersections, caused the BRT to be blocked at this intersection.

Figure 9.7-3: Lack of traffic enforcement



Poor management of intersections has a severe effect on BRT as a large portion of signal green time is wasted by persistent cross traffic violating red lights. Traffic rules enforcement is key.

Figure 9.7-4: Mixed traffic operation on an overpass



Traffic on overbridges are a major obstruction to BRT, as often the traffic is stopped. As BRT develops the city will need to make a policy decision, to remove private cars and motorcycles from the single lane overpasses and prioritize BRT.

Figure 9.7-5: improved discipline of traffic violators is needed

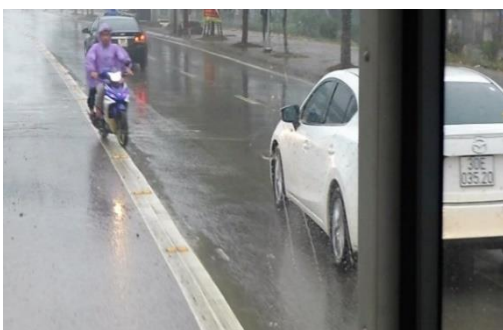

Lack of order (and consequently accidents) are largely due to the 'village driver attitudes' by motorists, who endanger themselves and others with undisciplined behavior, impulsive and erratic actions.

Figure 9.7-6: Ignorance of BRT rules is an accident risk

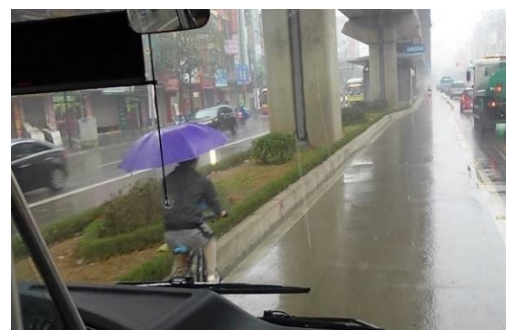

Cyclists regularly see the bus lane as a clear cycle path, putting themselves in high danger.

Source: Frits Olyslagers (2017)

This page intentionally left blank

10. India Three BRT Cities



Three medium-sized cities developed BRT under World Bank financing, including Hubli-Dharwad, Pimpri-Chinchwad, and Naya Raipur. In India, urban transport traditionally falls under the state government purview and local government is the weakest tier, especially the medium and small-sized cities. In spite of the institutional and technical challenges, the cities took on the formidable task of delivering BRT. Each of the BRT systems, whether BRT Lite in Naya Raipur or fully segregated BRT in the other two cities, received very positive public responses, achieved significant modal shift to public transport in the BRT corridors and most importantly, developed capacity through ‘learning by doing’.

Establishing the national and state-level institutional arrangement proved to be effective in project decision making and helps to ensure ongoing commitment in project cities. As the resource and capacity of medium-sized cities lags behind large cities, the intervention of a centralized and capable entity at a state level was effective in providing technical assistance to multiple cities. In the Hubli case, the proactive involvement of the state government created the Land Transport Department, connecting the city to urban transport grants to implement small innovations at the city level.

Hubli was clearly more successful; as it established a SPV BRT agency in Hubli-Dharwad which was able to coordinate planning, delivery and operations in a highly fragmented institutional setting. Whereas BRT ridership in Hubli-Dharwad rose to 100,000 daily, BRT in Pimpri-Chinchwad and Naya Raipur have yet to improve their ridership performance. The BRT implementation overcame the myriad of unforeseen problems in land acquisitions, community opposition, change to design drawings, staff turnovers and resultant design changes.

10.1. Multicity Program Introduction



India is rapidly urbanizing. Urban population is projected to grow from 290 million in 2000 to 590 million by 2030 and urban transport problems pose a serious threat to the environment both locally and globally. High level of air pollution has been part of daily life in many big Indian cities where streets are overloaded by motorized vehicles. Under these trends, India will soon be the world’s third largest consumer of oil, only after the US and China. Unless deliberate steps are taken to develop and implement an environmentally friendly urban transport strategy in the coming decades, India’s increasingly growing urban areas may well become the largest single source of GHG emissions increase⁷⁷.

⁷⁷ PID Document 2006

In 2009 the GoI formally requested the Bank and GEF to assist to develop adequate institutional structures and capacity for implementing the National Urban Transport Policy which will in turn, abate GHG emissions. The MoUD developed an India-GEF-World Bank-UNDP Sustainable Urban Transport Program (SUTP) to strengthen the capacity of national and local governments in urban transport planning and management in more integrated and comprehensive manner. The core of this multicity program involved a wide range of activities under both capacity building and demonstration projects. Through the demonstration projects, SUTP financed BRT systems for three cities: Hubli-Dharwad, Naya Raipur, and Pimpri-Chinchwad.

10.2. Project Development Objectives and Schedule

The Project's Development Objective (PDO) was to promote environmentally sustainable urban transport nationally and to improve the use of environmentally friendly transport modes in the project cities.

The length of implementation was 9 years from 2009 to 2018, having been amended seven times and extended twice to accommodate new developments. One extension was by one year in December 2012 to include Hubli-Dharwad BRT, and the second time by 28 months in November 2015 to ensure completion of five of the six demonstration projects, which were critical to the achievement of the PDO. The complexity of involving multiple cities and agencies required flexibility in implementation.

Figure 10.2-1: BRT in Project Cities



Source: Pimpri Chinchwad Municipal Corporation, and Nupur Gupta (World Bank)

10.3. Hubli-Dharwad

Hubli and Dharwad are twin urban communities, situated in the State of Karnataka. In 1961, the two cities merged to form the agglomeration of Hubli-Dharwad. Hubli-Dharwad Municipal Corporation is in charge of the city framework and organization of the twin cities. The population of Hubli-Dharwad, is 1.5 million (2018) with a population density of 4422 per square kilometer⁷⁸.

The SUTP financed the 22.25 km BRT corridor between Hubli and Dharwad. Before the project, public and private buses provided service between the two cities, at a travel time exceeding one hour. The BRT comprises 17.5 km of dedicated corridor and 5.25 km of mixed traffic lane, along with bus depots, bus stations, terminals and interchanges between city bus service and BRT, and NMT facilities. The BRT project also includes implementing an ITS and depot and terminal improvements for the city buses in general.

Figure 10.3-1. Hubli-Dharwad BRT

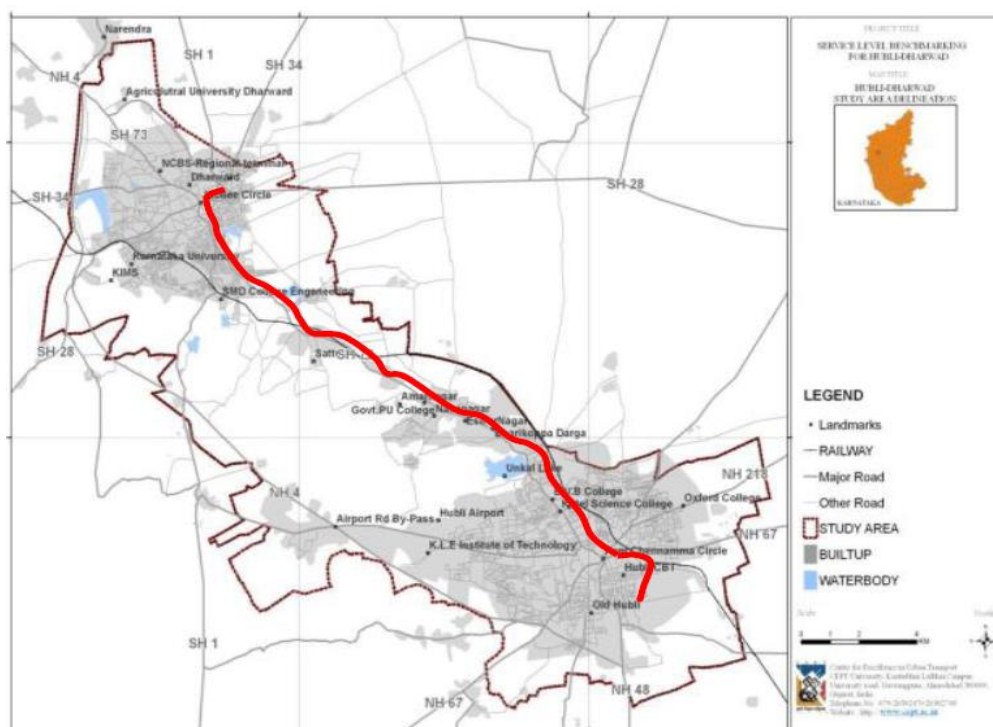

Source: Nupur Gupta, World Bank

The BRT in Hubli-Dharwad is managed by the Hubli-Dharwad BRT Co, operationalizing the project in October 2018 starting as a 5-bus trial, rapidly growing to an operation of 100 bus fleet. The daily ridership was 65,000 initially and is now reaching 100,000 with travel time having decreased from one hour to 35 minutes with express services. At opening, indications were that the BRT was able to retain 50 percent of the previous

⁷⁸ <https://indiapopulation2019.com/population-of-hubballi-dharwad-2019.html>

bus passengers, and that 18 percent of the users have shifted from personal modes of which 9 percent are from cars⁷⁹.

10.4. Naya Raipur

Raipur, the original city, was the capital of the State of Chhattisgarh and the major urban center in the state. Naya Raipur, is a planned city to replace Raipur as the official legislative capital city of Chhattisgarh and is being developed as a 'green city' under the Smart Cities Mission Program by the national government. The population of Raipur in 2019 was estimated at 1.87 Million⁸⁰, and Naya Raipur close to 200,000 people⁸¹.

Figure 10.4-1. Naya Raipur BRT

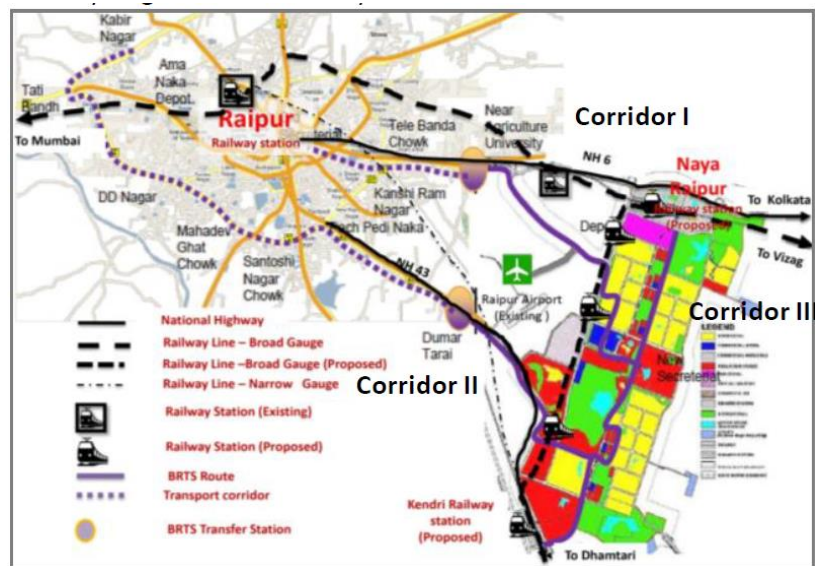

Source: Naya Raipur Development Authority

The SUTP financed the BRT Lite corridor (Corridor I in Figure 10-4.1) between Raipur and the newly developing administrative center of Naya Raipur, over a distance of 26 km, as an express service without a dedicated right of way. Before the project, and with the launch of the new state capital, passengers had to rely on personal modes of transport and a minimal public bus service. In order to avoid creating dependence on personal modes, the World Bank encouraged the Naya Raipur Development Authority (NRDA) to initiate an interim bus service. Accordingly, NRDA launched an employee-only government bus service as most commutes between the two cities were by government staff commuting to work. Two additional BRT corridors were planned: Corridor II as a BRT corridor linking Kabir Nagar (Raipur) with the Capital Complex in Naya Raipur (35 km) and Corridor III as a Quality Bus Service.

System operation was assigned to the Naya Raipur Mass Transport Ltd (NRMTL), an SPV Company commencing with Corridor II as a city bus service only and Corridor III only

⁷⁹ ICR 2019

⁸⁰ <https://indiapopulation2019.com/population-of-raipur-2019.html/>

⁸¹ <https://www.latlong.net>

partially operational with a plan for full operations as the population of Naya Raipur grows.

Daily ridership on the BRT Lite grew quickly from 950 at opening to more than 3,000 passengers per day by 2018. The public transport mode share of trips between Naya Raipur and Raipur reached over 42 percent at project close, a very significant achievement given the negligible public transport available in Raipur at the start of the project⁸².

10.5. Pimpri-Chinchwad

Pimpri-Chinchwad, under Pune Metropolitan Region in the State of Maharashtra, is part of an urban agglomeration comprising of Pune, Pimpri-Chinchwad, and Sangavi as well as Nigdi which is under the civic body. At 2019 its population was estimated at 2.2 million⁸³.

Pune City previously launched a pilot BRT in 2006 which was beset with many problems, which some critics blame on it not following established BRT standards⁸⁴. The actual causes are more complex, and show poor planning and design on many fronts⁸⁵. This haunted the Pimpri-Chinchwad BRT especially during the implementation phase.

Figure 10.5-1. Pimpri-Chinchwad BRT

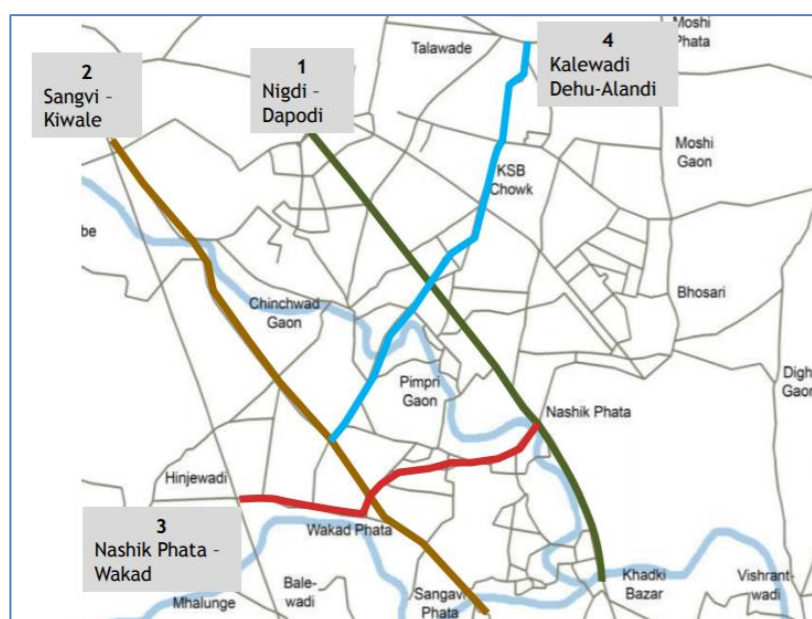

Source: Pune Municipal Corporation

⁸² ICR(2019): The World Bank Sustainable Urban Transport Project (P110371)

⁸³ <https://indiapopulation2019.com/population-of-pimpri-chinchwad-2019.html>

⁸⁴ ITDP (undated) Challenges of a Bus-Rapid-Transit System in Indian Cities: The Rainbow Case Study.

Source: <https://www.itdp.in/challenges-of-a-bus-rapid-transit-system-in-indian-cities-the-rainbow-case-study/> Last accessed 22/03/2020

⁸⁵ IBI Group and CEE Urban Program Group Centre for Environment Education, (2015) Learnings from Pune's Pilot BRTS Project Prepared as part of the Pune BRTS Promotions and Outreach Program for Pune Municipal Corporation. Page 31-37 show design improvements for the new Pimpri-Chinchwad route. Source: https://rainbowbrtpune.files.wordpress.com/2015/07/learnings-from-pune-pilot-brt-project_may-2015-1.pdf

Pimpri-Chinchwad city implemented a network of four BRT corridors, with the SUTP financing Corridors 3 and 4 – both greenfield corridors totaling 19km that connect the two parts of the city divided by a river, railway line, and major highway, creating a grid network. The system was branded as Rainbow BRT with a new image, incorporating successful elements and learnings from the pilot project and best practice.

The system operation was assigned to Pune Mahanagar Parivahan Mahamandal Limited (PMPML), a State Transport Undertaking (STU) being the traditional bus operator in the city.

At project completion, daily ridership on Corridor 2 was 80,000 and Corridor 3 17,000/day. Corridor 4 has since been operationalized. Of the passengers using BRT, 28 percent had switched modes from motorcycles, autorickshaws, walking, cycling, and cars. The overall public transport mode share for the city more than doubled, exceeding targets. Soon after its launch, the dedicated bus lanes enabled commuters to reach their destinations 10 to 15 minutes earlier than usual⁸⁶.

Rainbow BRT is yet to achieve its full potential. Ridership only increased by 12-17 percent over the three years while the number of personal motor vehicles on the road continues to grow unabated due to limitations of bus availability and resultant lower frequency of services. The ongoing Metro construction along Corridor 1, the most heavily trafficked corridor, has prevented the full operationalization of BRT services on that corridor.

10.6. Case Analysis: Government Commitment

India has traditionally underinvested in public transport. As of 2007, of 80 cities with a population size exceeding half a million, only 20 had organized public transport; and a large majority of bus operators had inadequate resources and technical know-how. In particular, medium-sized cities lack technical capacity and resources and have lagged in developing institutional capacity, as urban transport falls under the state government's purview and local government is the weakest tier.

The template developed by the national and state-level institutions responsible for public transport has strengthened the commitment, efficiency and capacity for project implementation to improve mobility in medium-sized cities.

In the case of Hubli-Dharwad and Naya Raipur, the stronger roles of the state government ensured a far more effective implementation process, which was instrumental in the implementation of BRT. In Hubli-Dharwad, the state government was directly involved to create the Land Transport Department, thus creating a centralized capacity to support multiple cities and using grants to implement small innovations at the city level.

⁸⁶ ITDP (2020) Challenges of a Bus-Rapid-Transit System in Indian Cities: The Rainbow case study.

Source: <https://www.itdp.in/challenges-of-a-bus-rapid-transit-system-in-indian-cities-the-rainbow-case-study/> Last accessed 22/03/2020

At the multicity program level, the combination of capacity-building and demonstration projects focused on technical assistance as a first intervention, building the capacity for the cities to develop their own sustainable urban transport initiatives, instead of an infrastructure-led approach where capacity building needs to ‘catch up’ or be expected to develop in parallel.

In the absence of consistent operational subsidy support to the BRT, sustaining the quality and level of service is an ever-present challenge. Since independence, subsidy was a consistent part the transport funding arrangement in India until 1988, when the Govt of India modified its policies, withdrawing financial support, with the states largely following suit. This resulted in a low fare revenue base that was insufficient to cover the operational costs. Identifying and designating non-revenue and subsidy sources is key to meeting operational deficits and sustaining the BRT operations and infrastructure renewal. It is important that the cities pursuing BRT earmark such revenue sources so that quality BRT infrastructure and service can continue to be maintained.

10.7. Case Analysis: Institutional Arrangements and Operations Management

The fragmented governance of city and state, demands that more attention is given to the coordination mechanisms, establishing clear definition and assignment of roles in the implementation and operations of BRT.

In **Hubli-Dharwad**, the state (Government of Karnataka) established the Hubli – Dharwad BRTS Company Ltd (HDBRTS Co) as a Special Purpose Vehicle (SPV) to coordinate the planning and delivery of BRT, conduct its operations, and be the owner of the assets. This was a key factor in the success of the BRT. Apart from the Government of Karnataka⁸⁷, shares in the company are held by the Hubli–Dharwad Municipal Corporation (HDMC), Hubli–Dharwad Urban Development Authority (HDUDA) and North Western Karnataka Road Transport Corporation (NWKRTC). The NWKRTC is the state-run bus service company in Karnataka and it has blended BRT operations into its city bus service and an inter-city service.

In **Pimpri-Chinchwad**, a lack of clarity exists in the definition of roles. The Pimpri-Chinchwad Municipal Corporation (PCMC) developed the BRT infrastructure, but Pune Municipal Corporation failed to develop sections of Corridor 1 and 2 which fell within their geographical limits. However, at the end of the project, based on the success of the BRT in Pimpri-Chinchwad, Pune had revived the proposal for extending the BRT.

The Pune Mahanagar Parivahan Mahamandal Limited (PMPML), a State Transport Undertaking (STU⁸⁸), is the public transport bus service provider for the twin cities of Pune and Pimpri-Chinchwad. It operates the Rainbow BRT routes and more than 300

⁸⁷ <http://www.sutpindia.com>

⁸⁸ The State-owned Undertakings (STU) are state-owned public bus operating entities usually in the form of a corporation, regulated by government.

local routes within a radius of 20 km around the two cities including the local service connecting with the BRT corridors. However, in the absence of a dedicated entity (such as the HDBRTS Co in Hubli-Dharwad) *neither the municipality nor the bus company fully owns the project*⁸⁹. At project completion, the weak capacity of PMPML and a deteriorating fleet contributed to both a declining service on its BRT corridors and poor financial performance, despite a positive response from the public at that time (ibid).

In **Naya Raipur**, the Naya Raipur Development Authority (NRDA), responsible for the management and urban governance of Naya Raipur, led the BRT development. The Naya Raipur Mass Transport Ltd (NRMTL), an SPV company, operates the BRT. However, the SPV suffers from limited staffing and financial constraints.

10.8. Implementation Experience

In consideration of the institutional and technical barriers, these medium-sized cities took on the challenges and delivered BRT, with very positive public responses and ongoing expansion in all three cities.

The following implementation experiences may be more unique to India, but highlights the very real obstacles that can beset a BRT implementation program:

Firstly, protracted land acquisition and resettlement caused substantial delays in Pimpri-Chinchwad and Hubli-Dharwad, exacerbated by outdated land records, large informal settlements, frequent litigation and court cases, and limitations in the capacity of city agencies to manage the issues. According the World Bank ICR, in Pimpri-Chinchwad, planning estimated about 1,200 affected persons, however, upon implementation more than 10,000 landowners and more than 400 families including 144 informal settlers were displaced. As a result, the project experienced delays in resettlement, payment of compensation, land handover to contractors as well as prolonged court cases, longer stay of displaced families in transit camps and so on. The weak capacity of the PCMC also contributed to the delay. In the case of Hubli-Dharwad, the impacts included land acquisition of 30 acres affecting 1,043 landowners and 500 tenants and informal settlers and displacement of 21 families, and encountered resistance from religious trustees for relocation of affected worship structures. This required proper compensation rates for private lands, and compensation for road margin areas. Relocation of affected workshop places was one of the most challenging in the Hubli-Dharwad BRTS.

Stakeholder communication and coordination was essential yet time consuming, in finalizing designs, completing implementation, and finalizing operating arrangements across cities. The agreements with regard to the rolling stock designs between the twin cities, Pune and Pimpri-Chinchwad took time, and similar delays were encountered for ITS. In Hubli-Dharwad, HDBRTS Co had to coordinate continuously with NWRRTC, the public transport operator, first on the designs and later on the operations plan and operating arrangements. Coordination with Railways in all three BRT projects for

⁸⁹ ICR(2019): The World Bank Sustainable Urban Transport Project (P110371)

approval of rail-over-bridge (RoB) designs and implementation could have been quite protracted but for the efforts of the national project management unit to facilitate progress. In Naya Raipur, the BRT pickup point in central Raipur at the railway station is now a model for intermodal integration, but took almost three years to reach agreement with the Railways. Finally, the coordination with Traffic Police, though critical for the success of the BRT was slow and difficult for the agencies, as the Police were not prioritized as a stakeholder in the beginning.

10.9. Case Analysis: Lessons Learned

- **Because a BRT project requires coordination and management of vast and disparate aspects**, a dedicated lead agency (BRT Company) needs to be assigned the authority to prepare, implement and operate the system, taking the project forward while continuously coordinating with fragmented stakeholders, including the Traffic Police for lane enforcement and managing driver behavior. Land acquisition and taking away road space for BRT and managing contestations over street space are significant hurdles to overcome.
- **The project planning and schedule needs to be very thorough.** The scale and innovation of the project requires a much stronger preparation for land acquisition, resettlement and utility shifting, project designs including alternatives analysis and stakeholder consultations, operations planning and financial analysis etc. and more time to cope with the unforeseen risks and allow time for the cities to 'gear up'.
- **Project commitment and the priority accorded to the project at the agency level needs to be solid.** Changes in officials contributed to delays in finalizing designs, completing implementation, and finalizing operating arrangements. It is crucial to ensure the continuity of a dedicated team of project officials appropriately delegated by the administrative and financial powers.
- **Delays become a vicious cycle.** When projects encounter delays, problems of weak local technical skills for planning and implementation are exacerbated. Staffing problems arise when there are delays in filling posts, or where staff are assigned on a part-time basis. If staff are often overloaded it leads to frequent staff turnover.

This page intentionally left blank

11. Lagos, Nigeria



The Lagos BRT commenced with a government sponsored 'BRT-lite' using a design approach which could readily deliver the physical segregation of BRT buses from other traffic to provide commuters with a clean, affordable and reliable means of getting around in the city, delivering immediate benefits, in terms of bus run times, timesaving and convenience. It was a pragmatic solution, concentrating infrastructure on where it had the best impact.

It was built in a relatively short time (15 months) with low costs (\$1.7 million per km) and achieved high ridership. The 22 km Mile 12 – CMS pilot Bus Rapid Transit (BRT) Lite scheme (Phase 1) was financed by the Lagos State, with World Bank support for pre-feasibility study and assistance to engage with private operators and commercial banks, communications design, and setting up evaluation and monitoring. Building on this initial success, the WB financed Phase 2 BRT, comprising improvements to Phase 1 and a full median BRT corridor extension to Ikorodu, operationalized in 2017, achieving a 40 percent reduction in travel times and 30 percent in travel mode shift.

The transport authority LAMATA proved itself with the successful transport reform and implementation of BRT, managing coordination, planning and regulation with full engagement of stakeholders, taking a 'whole of package' approach in consensus building, operations and service planning. Early inclusion of informal bus operators encouraged their cooperation and acceptance. It also applied a 'design and build' methodology to construction to avoid design and construction delays.

The crisis of deteriorating performance of the first BRT operating company for BRT Lite, is an example of the effect of the business model on behavior. In this case the operator sought to exploit its management role to seize control over revenue. LAMATA prevailed and has capably managed numerous challenges to the efficient operations of BRT.



11.1. City and Urban Transport Context

Lagos, the most populous city in Nigeria, is the most populous city in Nigeria, and the ninth fastest growing city in Africa. Lagos city, known officially as 'Lagos Metropolitan Area' is actually an urban agglomeration in the Nigerian state of Lagos. It covers an immense area, coming in with a total of 1,171.28 square kilometers (452.23 square miles). With the population continuing to grow, and currently exceeding at least 17 million residents, the population density is around 6,871 residents per square kilometer⁹⁰. A large gap exists between the wealthy and poor in Lagos with about 66 percent of the population living in slums⁹¹.

⁹⁰ <http://worldpopulationreview.com>

⁹¹ Bayo Olupohunda On Lagos' Challenges Of Rapid Urbanization (2015) <https://www.legit.ng/623803-time-sink-swim-lagos-challenges-rapid-urbanization.html>. Last accessed 22/03/2020

Authorities have had difficulty in meeting service demands of a growing population, particularly the poor, who are most dependent on public services, compounded by urban sprawl which has multiplied the challenges and increased travel distance and cost. Low-income groups have been proportionately affected, finding themselves excluded from work and social services. Meanwhile, the middle class increased their private car use and aggravated traffic congestion, affecting health and safety of other road users.

Furthermore, road infrastructure lagged 20 years behind demand, and was low even by African standards. Public transport was highly fragmented, of poor quality with no regulatory oversight. Bus fares at about \$1 per trip consumed over 20 percent of the average household disposable income.

Most notably, BRT Phase 1 has reduced on average, fares by 30 percent, reduction in journey time by 40 percent, with a 35 percent reduction in average waiting time, and increased patronage from sectors that had hitherto shied away from public transport, namely children, car owning middle classes, the elderly and the less able⁹².

11.2. Project Development Objectives and Schedule

Lagos implemented two phases of BRT: Phase 1 - BRT Lite was financed by the Lagos State (as a curbside BRT) and its success led to the implementation of Phase 2 BRT median lanes which was supported technically and financially by the World Bank.

The Phase 2 project development objectives were to (a) improve mobility along prioritized corridors and (b) promote a shift to more environmentally sustainable urban transport modes. The total period of the Phase 2 implementation for the project was six years from 2011. The original project closure was in June 2015, but three restructurings occurred in 2011, 2012 and 2015 extending the close date to May 31, 2017.

11.3. Case Analysis: BRT Design

Phase 1: BRT Lite

The first corridor, the 22km Mile 12 – Church Missionary Society Pilot (BRT Lite), was launched in 2008, aiming to provide Lagos commuters with a clean, affordable and reliable means of getting around in the city. This BRT Lite corridor was constructed with Government funding as the Government decided that the BRT system was not necessarily a long-term grand aspiration, but something readily deliverable.

Its pragmatic design delivered bus lanes of which 65 percent is physically segregated from other traffic, 20 percent marked in paint, and 15 percent operating in mixed traffic. Bus lanes are typically 3.3 meters wide and are separated from other traffic by concrete curbs that are 40cm high. LAMATA provided bus lanes, 3 terminals, 26 stops, one depot, and managed the regulation, enforcement route planning, and operational specifications. Private sector operations were undertaken by a cooperative formed

⁹² LAMATA. (2020) Source: <https://www.lamata-ng.com/services/brt-bfs/> Last accessed 22/03/2020

under the National Union of Road Transport Workers (NURTW) being the First BRT Cooperative Limited, who procured buses, managed operations and maintenance. The BRT Lite corridor was delivered in a relatively short time frame, taking 15 months - from conception to operation at a cost of \$1.7 million per kilometer⁹³.

Figure 11.3-1: An Artist's Rendering of BRT-Lite Corridor (before and after)



Source: Dayo Mobereola

The system performance is reported⁹⁴ as:

- Carrying over 400 million passengers in the last five years;
- Average daily ridership is 180,000 passengers;
- Average load factor of 800 passengers carried per bus daily;
- Average daily trip per bus per day is 5;
- Average waiting time is 15 minutes;
- Average speed is 30km/h.

Project planners also evaluated certain design aspects and provided justifications for their decisions, including:

- Developing a quality bus system that is affordable in the local context and applicable to local operating and physical environments while retaining as many of the most desirable BRT characteristics as possible.
- Given the poor record of public bus operations, the government committed to a PPP where it accepts responsibility for the enabling environment and infrastructure provision, and the private sector is responsible for management, service delivery, including providing and maintaining the bus fleet.

⁹³ Mobereola, D. 2009 Africa's First Bus Rapid Transit Scheme -The Lagos BRT-Lite System SSATP Discussion Paper No. 9, World Bank.

⁹⁴ LAMATA. (2020) Source: <https://www.lamata-ng.com/services/brt-bfs/> Last accessed 22/03/2020

Phase 2: Full-Scale BRT

The BRT component under the Bank funded LUTP2 continued the investment in BRT Lite through upgrading the first BRT corridor from Mile 12 to CMS and rehabilitating shelters, constructing segregated median BRT infrastructure for the BRT Lite corridor extension and road widening from Mile 12 to Ikorodu.

‘Design & build’ contracts were signed with contractors, who worked largely from the preliminary engineering design produced by consultants, thus reducing preparation time. The consultants and contractors worked together to ensure that the concept was carried through to construction. Along the BRT-Lite corridor, new shelters were built to give order and structure to vehicle boarding. Tickets are purchased upon entering the stop, and passengers then queue before entering the bus. The shelter protects passengers from the sun by means of an opaque glass canopy. A similar design style is used at the terminals, where more space is provided for boarding and alighting.

Figure 11.3-2: BRT Lite Corridor



Source: Dayo Mobereola

Figure 11.3-3: Comparison of Phase 1 BRT Lite (Left) and Phase 2 BRT (Right)

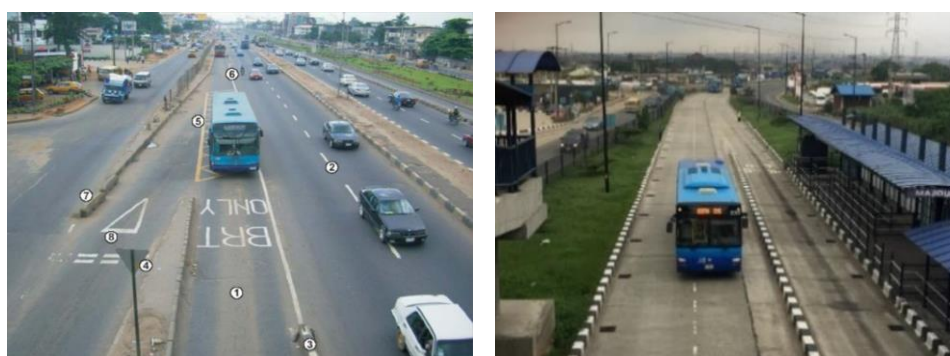

Source: Dayo Mobereola, Left; Roger Gorham and Fatima Arroyo (World Bank), Right

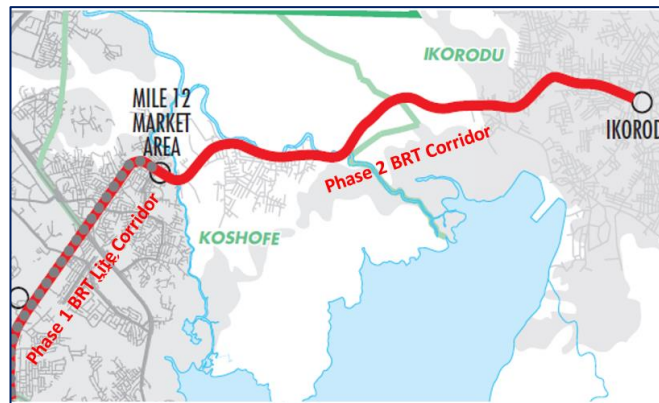
Figure 11.3-4: Phase 2 New BRT Corridor to Extend the BRT Lite Corridor

Source: PAD, World Bank

11.4. Case Analysis: Government Commitment

BRT was driven in Lagos by strong political will of two recent governors Tinubu and Fashola, as well as other key officials, and as urban dysfunction in Lagos is widely shared between elites as well as the poor, there was also public support for bold initiatives, with broader goals—to secure political kudos by developing a modern, orderly, and prosperous megacity⁹⁵. The political climate emanating from elections held in 1999, created both the conditions (stability and continuity) and incentives (political and economic benefits) for governance reform. However, while Lagos politicians have a compelling interest to provide a better-run bus system, they faced a politically powerful bus drivers' union with staunch patronage demands.

Other ways in which government has shown its commitment includes the establishment of a competitive salary structure in comparison to civil service wage, providing stable funding for LAMATA from the Transport Fund in the early years. However, at one point, the Governor of Lagos wanted to seize control of LAMATA, so the State stopped the funding from the Transport Fund and changed laws to reduce the autonomy of LAMATA (discussed further below).

11.5. Case Analysis: LAMATA as the Urban Transport Authority

LAMATA stood out as an exemplary agency, well-positioned to take up the Bank funded BRT project, as it had the advantage of previous experience with private sector participation through road maintenance works prior to the BRT project. Its leadership tactically invested and built up the agency's technical capacity in a short timeframe under the effective leadership of the prior Managing Director, Dayo Mobereola, developing capable practitioners in all aspects of urban transport. The Bank's ICR for LUTP2 recognized LAMATA's strong leadership and capacity as critical to the success of urban passenger transport in Lagos.

⁹⁵ Mason Jones, K. Cohen, B. (2012) WWF-SA Source: http://awsassets.wwf.org.za/downloads/lcf_lagos_brt_2012.pdf last accessed 14/2/2019 and Gramont, D. Governing Lagos: Unlocking the Politics of Reform.

Source: <https://camegiendowment.org/2015/01/12/governing-lagos-unlocking-politics-of-reform-pub-57671> Last accessed 19/2/2019.

Capacity building was instrumental, and LAMATA's leadership, with state support, developed and implemented strategies for talent recruitment and training, including:

- Merit based recruitment in the market. Interested civil servants had to go through the same competition process as outside competitors.
- Priority to citizens in Nigeria of comparable technical strength. The advantage of a strong civil engineering curriculum in the Nigerian universities provided LAMATA with the opportunity to train civil engineers in transport engineering.
- Proactive overseas recruitment of seasoned practitioners of Nigeria origin for high level positions, offering net salaries comparable to those in the developed cities.
- Commitment to capacity-building included an apprentice program with Transport for London (TfL). Since the establishment of LAMATA more than a decade ago, the agency had committed itself to capacity building, two months of training targeting bus operations, traffic management and other expertise that the city lacked. Among these efforts, the TfL apprentice program proved effective, where selected LAMATA staff were embedded in the TfL operations in London and gained real world experience and contributed to TfL operations.

The capacity development took nearly three years to start, showing results in the agency's operations, especially in the areas of bus operations and traffic management. In parallel, the LAMATA leadership strategically prioritized quick actions to implement safety measures and improve project management to make the agency visible and earn the trust and support of the public and Lagos State. Because of all these efforts, staff morale is high with low staff turnover and the agency is held in high esteem.

Besides capacity building, the long-term World Bank engagement in Lagos has allowed LAMATA, the implementing agency, to mature. LAMATA has been successful in (a) preparing a strategic long-term plan for the transport sector in Lagos; (b) coordinating activities of the multiple agencies; (c) rationalizing motor vehicle tax administration - resulting in a substantial increase in revenues; (d) maintaining, upgrading, and rehabilitating 632 km of the declared road network; and (e) implementing BRT Lite and then BRT. LAMATA is also responsible for the design and execution of maintenance work with participation of the local consultants and contractors.

The 13-member LAMATA Board comprise transport operators, transport unions in Lagos State, the organized private sector, the general public, local government, and transport related Lagos State agencies. In March 2007, LAMATA was given the power to regulate franchises, and to award concessions for exclusive operating rights on defined routes or in specific geographical areas, but was later undermined by LAGBUS, the conventional public bus operator.

Due to the issues of the BRT cooperative operator obtaining credit, Lagos State nominated LAGBUS, the conventional public bus operator, as a government-owned holding company to finance the fleet and make vehicles available to private operators through leasing arrangements. However, perhaps due to political motivations during the election, the government mandated that LAGBUS put these buses into operation directly, which was incompatible with the law governing the role of LAMATA, thereby undermining LAMATA's autonomy. LAMATA had been the intended authority to govern public transport in Lagos state, but LAGBUS refused to recognize its authority.

Initially, after seeing the success of BRT Lite, LAGBUS tried to initiate their own “BRT” services, with lane painting on certain roads and BRT written in paint in the lane periodically. In 2012, LAGBUS, by then referred to as *the company in charge of managing and operating the BRT service*, began giving out bus operating franchises to ‘man-and-his-bus types’ of operators. *A number of these operators accessed BRT lanes, claiming the right to use the BRT lanes and undermining BRT operations.* As of 2016 the number of BRT franchisees had increased to about 37. Finally, the government decided to enforce BRT lane exclusivity. Nonetheless, there had been years of operation where multiple operators competed for the use of BRT lanes.

11.6. Case Analysis: Operations Management

11.6.1. Operations Management under Phase 1 BRT Lite

In the mid-2000s, there appeared no single private-sector undertaking capable of operating the BRT-Lite system on its own. The National Union of Road Transport Workers (NURTW), a union representing drivers and workers in the transport sector in urban and small-bus services, established a special purpose entity to operate BRT Lite — Lagos NURTW (First BRT) Cooperative Society Limited, also referred to as First BRT Cooperative (FBC). The FBC was a legal entity formed specifically for the purpose of the bus franchise scheme, and able to enter into contracts both for the franchise and the vehicle lease⁹⁶.

Acquiring buses proved to be quite challenging for the BRT operators, finding initially that no financial institutions were willing to participate. The vehicle supplier eventually resolved this matter by offering to accept deferred payment over two years, provided that a local bank underwrite the counterparty risk. Ecobank Nigeria agreed to this arrangement, but it, in turn, required that senior officers of NURTW lodge collateral personal guarantees in order to mitigate that risk exposure⁹⁷. A steering committee comprising FBC, LAMATA, and the funding bank was established to provide professional advice on the management of the cooperative and BRT operations. **This steering committee was an effectively-placed control system, to which the initial success of BRT Lite service and FBC as an operator can be attributed. However, when this committee later dissolved, the FBC and BRT Lite service quickly degraded.**

In summary, implementation strategies for the BRT Lite included:

- Formation of the Cooperative comprising Union members on the BRT corridor, recruiting mainly union members for their operations;
- Establishment of a steering committee comprising LAMATA and the funding bank that provided an effective mechanism of supervision;
- Separating BRT operations and revenue collection. In the early years of BRT Lite, the funding bank acted as a de facto “third-party” revenue collector. It sold the fare tickets, paid LAMATA, then paid the cooperative after retaining their own principal and interest payment;

⁹⁶ LUTP2 Project Appraisal Document, World Bank

⁹⁷ Mobereola, D. 2009 Africa’s First Bus Rapid Transit Scheme -The Lagos BRT-Lite System SSATP Discussion Paper No. 9, World Bank

- Bi-lateral operation with regular buses/mixed traffic operating on the service lane and BRT buses operate on the BRT lane;
- LAMATA recruited and trained members on the running and management of BRT, assisted by professionals that were seconded to the cooperatives to assist on the job training;
- LAMATA provided start up assistance by providing uniforms, payment of salaries, training, etc.⁹⁸

Communications and public engagement also played a critical role as at the time of BRT commencement, as there was a suspicion of motives, requiring LAMATA to undertake strategic public engagement to foster a sense of ownership among the stakeholders. LAMATA targeted three types of demographic groups: 1) the captive public transport users; 2) motorists owning vehicle that gave them choice, and 3) higher income groups. During the consultation, the BRT scheme was explained as a way to solve an individual's own problems. *Through this approach, the sense of ownership was developed.* During the construction, LAMATA conducted advertising within the corridor in newspapers and on TV and radio, including a video on how to use the BRT Lite. LAMATA also held meetings with NURTW and its members along with other operators, to strengthen the conviction that BRT will improve the quality of life for Lagos' citizens⁹⁹. As a result, the BRT design reflected the public input and received public support.

11.6.2. Operations Management Under Phase 2 (LUTP2)

In 2016, the Ambode-led government of Lagos state abruptly banned the operators under its franchise scheme and terminated the contract of the FBC which operated the NURTW-owned BRT buses. The reasons given was persistent breach of the franchise agreement. This affected 36 BRT franchisees who were banned from operating on BRT corridors, leaving them to operate in mixed traffic.

It appears that the underlying reason of the failed FBC contract was the shifting power balance between LAMATA and the operator. When BRT Lite started, LAMATA established a committee inclusive of LAMATA, the Operator, and the Bank¹⁰⁰ that financed the fleet, holding weekly meetings to review expenditures and revenues before releasing the funds. FBC was in charge of running the service, and the Bank served as a revenue collector and distributor. The mechanism was transparent and worked effectively, beyond just the benefits of monitoring financial performance. However, the operators, benefitting from high revenue, paid off the bus fleet in the first three years, and *then demanded to manage revenues by itself, effectively dissolving the committee, and freeing itself from financial oversight.*

With the easing of pressure to maintain financial discipline, the BRT cooperative, lacking business discipline, was no longer constrained by effective supervision. *This resulted in declining performance and operational issues which were not addressed by*

⁹⁸ Orekoya T. (16 March 2010) LAMATA. The Bus Rapid Transit system in Lagos Nigeria - A Presentation to United Nations Forum on Climate Change Mitigation, Fuel Efficiency & Sustainable Urban Transport, Seoul, Korea.

⁹⁹ Mobereola, D. 2009 Africa's First Bus Rapid Transit Scheme -The Lagos BRT-Lite System SSATP Discussion Paper No. 9, World Bank.

¹⁰⁰ As a condition of fleet financing the bank lender was given an initial lien on revenues collected, and after fleet payments were made, the balance was passed on to the operator. The lending bank took a role ticket distributor and security monitor.

the operator and weakened LAMATA's control. LAMATA made many attempts to warn the operator over poor performance.

Following the termination of the FBC contract the government appointed a private company, Primero Transport Services Limited as sole BRT bus operator. Primero's operations cover the entire new BRT corridors operating a 24-hour bus service with 400 new buses with air conditioning, the first of its kind in Nigeria. The entry of Primero set market precedence, which began to attract private companies to BRT operations, creating market interest. However, Primero reportedly have their own issues, as reported in March 2018 when BRT ticket sellers stopped selling tickets, allegedly due to salaries not being paid, and lack of available fleet due to interruption to fuel supply¹⁰¹.

LAMATA recognizes that a single operator in Lagos limits the agency's negotiating power and is not conducive to efficiency gains over the long run. LAMATA is exploring the strategy of using other private operators in the downstream corridors to gradually build up private sector competitiveness in the market.

11.7. Case Analysis: Lessons Learned

A number of key learnings stand out from Lagos' BRT implementation experience, being:

That a BRT project does not necessarily need to achieve "full BRT" status to be successful; instead it can use a variety of bus system improvements appropriate to the local conditions and context. The Lagos experience has shown that an effective, high-capacity BRT system can be achieved using relatively low-tech and cost-effective means. The pragmatic approach applied to design was also applied to project management.

LAMATA understood the timing issues well, with strategically prioritized quick actions facilitating early and effective public engagement to build up public trust and acceptance. It also applied a '*design and build*' methodology to construction to avoid design and construction delays.

Capacity building has been instrumental, enabling LAMATA not only to deliver a successful project, but also to manage the onslaught of political maneuverings and risks that it encountered. An extensive skills development program at the outset in all aspects equipped LAMATA to be a competent authority.

Failure of the FBC contract has highlighted the importance of a business model that manages risks. The First BRT Cooperative was able to seize control over revenue and exploit the power advantage to reduce its accountability and thereby weaken LAMATA's control. This serves as a reminder that in contracting, the balance of power between the parties will affect performance and behavior.

¹⁰¹ Eremen B. Source: <https://guardian.ng/opinion/the-shame-of-lagos-state-brt-2/> Last accessed 5/2/19.

This page intentionally left blank

12. Lima, Peru



Lima's impressive achievement was establishing a BRT system out of a chaotic transport situation and delivering urban mobility improvements that delivered a 34 percent reduction in travel times and a dramatic drop (65%) in serious accidents in the corridor. A large reduction in emissions and pollutants has been achieved due to the choice of natural gas on buses, and a generating modal shift from car to bus.

Political support was also outstanding, as the Mayor was prepared to replace upper management to achieve the progress desired. Despite some delay, once the system was fully operational, it exceeded its target demands and achieved 82 percent of users being satisfied or very satisfied with the service (compared to 13 percent of users satisfied with the services prior). Through streamlining public transport routes, the project has contributed to the reduction in GHG emission and air pollution, and has begun to remedy many of the unsafe traffic characteristics plaguing the city. BRT implementation also provided hands-on experience for a newly established Protransporte to develop capacity for mass transit planning and operations.



12.1. City and Urban Transport Context

Lima is the capital city of the Republic of Peru and is both a Provincial Municipality (MML) and a District Municipality that comprises 43 district municipalities, each with its own mayor and municipal government administration. The provincial mayor leads the Metropolitan Council of Lima and at the same time is mayor of the district of Lima.

The city is the core of the Historical Lima Metro Area, one of the ten largest metro areas in the Americas. Lima's estimated population is almost 10 million people who live in the 43 districts in Metropolitan Lima¹⁰², under the jurisdiction of the Metropolitan Municipality of Lima (MML) which is responsible for public transport and roads, but does not share in their tax revenue, resulting in the municipality's poor state of finances. Overall MML revenues are derived from a mix of taxes levied at the provincial level (e.g., a vehicle tax), taxes and fees levied at the district level (e.g., the property tax), transit tolls from its own semi-autonomous toll road enterprise, and transfers from the central government¹⁰³.

Over the past two decades, rapid motorization has tripled vehicles on the city's roads, rising from a steady 270,000 in the 1980s to about 1 million in 2000s, while at the same time public transport trips reduced.

¹⁰² <http://worldpopulationreview.com/world-cities/lima-population/>

¹⁰³ US AID (2004) Are Semi-Autonomous Revenue Authorities the Answer to Tax Administration Problems in Developing Countries? A Practical Guide

In the 1990s' deregulation of public transit resulted in an oversupply of taxis and unregulated transit vehicles, causing a deterioration of the services. By early 2000s, the fleet of aging buses was estimated at 60,000 fleet, with an average age of 16 years and many exceeding 25 years, making Lima's public transport fleet the oldest in Latin America. This also led to paralyzing congestion and high rates of transit accidents (averaging four fatalities per day) and diminished the quality of life – especially for low-income residents who spend hours commuting from outlying communities. Air and noise pollution levels ranked among the highest in the region.

IN 2002, Lima's Metropolitan Municipality¹⁰⁴ established Protransporte as a transport authority to take charge of the public transport development, and to develop the Metropolitano project, which is the first high capacity segregated corridor operating on Lima's North-South axis. The launch of Metropolitano BRT and Metro Line 1 (elevated rail) in 2011 were tremendous steps forward, with the two lines carrying about one million passengers per day as at 2015¹⁰⁵.

12.2. Project Development Objectives and Schedule

The main objectives of Bank financing was to assist the MML to enhance economic productivity and quality of life within the metropolitan area; establish an efficient, reliable, cleaner and safer mass rapid transit system; and to improve mobility and accessibility for the metropolitan population, especially in the poorer peri-urban neighborhoods.

The total length of implementation was 7 years starting from 2004. The original plan for the implementation was only 5 years to close the project in 2009, but with two loan amendments in 2008 and 2009, the closing date was extended to April 2011.

12.3. Case Analysis: BRT System Design

The planning of Lima's BRT system took into account several criteria and objectives: (i) construction capacity, (ii) total passenger demand, (iii) speed or cost of execution (because the Via Expresa already had a busway, execution was less costly and faster since it required fewer changes to street configurations and infrastructure), and (iv) attention to poor populations (OVE 2016:15)¹⁰⁶.

Construction of the Metropolitano BRT began in 2006 and it opened in October 2010. The planned corridor length was 29.4 km of high-capacity bus corridors, but only 27.48 km were constructed¹⁰⁷. The system has only one line as shown in Figure 12.3-2.

¹⁰⁴ <https://www.bnamericas.com/company-profile/en/instituto-metropolitano-protransporte-de-lima-protransporte>

¹⁰⁵ Lima Urban Transport: On the Way to Transformation October 8, 2015 <http://www.worldbank.org/en/topic/transport/brief/connections-note-22> LA 24/03/19

¹⁰⁶ OVE (2016) Urban Transport and Poverty: Mobility and Accessibility effects of IDB-supported BRT systems in Cali and Lima. Office of Evaluation and Oversight, OVE. p15.

¹⁰⁷ There was a reduction of 1.92 km. due to environmental reasons.

Figure 12.3-1: Lima’s Metrolinea BRT



Source: Embarq

Source: OVE

The system operates four regular services, 11 express services and 21 feeder routes. As of 2018, the system carries 700,000 users per day.¹⁰⁸

Figure 12.3-2: Trunk Route and Stations



Source: <http://whereismybus2014.blogspot.com/2014/11/ruta-troncal-del-metropolitano.html>

12.4. Case Analysis: Government Commitment

The Independent Evaluation Group (IEG) of the World Bank Group stated that the project benefited from strong political commitment during the initial years especially from the Mayor of Lima, who was supportive of BRT system development.

Some criticism was made that full political support was not given to prioritizing NMT over motorized transport and that issues of implementation were not immediately dealt with at the highest level ¹⁰⁹. Nevertheless, it must be acknowledged that governments need to manage many facets of a project’s political and social environment, and in this case the city ultimately delivered an effective project.

Because of its high visibility, the project became a magnet for political dispute, particularly on the relative emphasis of BRT vs. Metro which caused delay in extension of Metropolitano and consequently underutilized the capacity of the Metropolitano BRT system¹¹⁰.

¹⁰⁸ www.metropolitano.gob.pe

¹⁰⁹ ICR, 2012. (IBRD-72090 TF-52877 TF-52856)

¹¹⁰ World Bank IIG Project Performance Assessment Report Republic of Peru LIMA TRANSPORT PROJECT (IBRD-72090 TF-52877 TF-52856) December 17, 2015

12.5. Case Analysis: Institutional Arrangement

Protransporte consolidated Lima's Urban Transport Sector through improved planning, supervision and control, and management capacity of the participating institutions.

Some challenges were experienced, as *Protransporte*, a decentralized public entity of the MML was created to implement and operate BRT projects in that city, starting as a Project Implementation Unit.

During its initial years, the organization's weak capacity delayed the project, due to staff's limited experience in the administration and execution of BRT projects and low wages. It soon became evident that BRT project was not merely an infrastructure or civil works project; but an entire urban-sector transformation that included a public-private partnership for the concession of buses and the fare collection system, among other key elements. Staff with higher levels of technical expertise were needed (implying that remuneration would need improvement). Concerned about the lack of progress the Mayor rotated senior management teams three times, including senior and middle management and professional staff. Since August 2007 the project has had relatively stable management and staff teams.

According to the ICR, *Protransporte's* capacity to manage and operate the Metropolitano has improved and it is becoming a more robust authority. Services are improving and routes that compete against the Metropolitano will be removed soon. A second corridor is being prepared.

12.6. Operations Management

The El Metropolitano has directly improved people's lives in Lima by saving of over 50 percent in travel time, giving a fare discount over long distance (flat fare) and improving safety with significant fewer accidents compared to conventional buses¹¹¹.

Upon launch, it became clear that passengers may not use the BRT system right away, and it took 1-2 years for ridership to improve. This caused financial insecurity for operators as passenger numbers were below target even after five years of operation¹¹²; the situation being particularly serious in the initial operating stage. The private bus operator concessions did not include a minimum revenue guarantee from the MML resulting in declining service as operators struggle to survive. A key observation is that notwithstanding the logic of placing some risk with the operator as an economic performance incentive, such risk should be manageable, and be set within a sustainable business model.

Once passenger numbers increased, overcrowding at stations and on feeder buses in low-income neighborhoods was a problem¹¹³ with long lines and delays for charging

¹¹¹ Cityfix 2013. Interview with Hernan Navarro, Operations Manager at El Metropolitano Source: <http://thecityfix.com/blog/interview-herman-navarro-el-metropolitano-lima-peru-brt/> LA 15/02/2020

¹¹² WB IEG PPAR

¹¹³ OVE conducted focus groups were conducted in Lima in February 2016 in low-income neighbourhoods in the north and the south.

cards and for passengers to board the buses. 15-minute delays are common for both feeder and trunk lines and many passengers are passed by when buses are full. Planners have recognized that stations need to be sized according to public demand, which necessitates building larger facilities in popular locations.

12.7. Case Analysis: Impacts on the Poor

The poor in Lima tend to live in the periphery of the city, in the northern and southern cones, while high-income populations are concentrated in the central and south-central areas of the city. Peripheral areas of Lima are defined as all areas at least 9 km from the city center where 42 percent of the extreme poor and 19 percent of the poor population live, being outside the immediate area of coverage of the mass transit lines and where the extreme poor often reside in informal settlements characterized by a general lack of infrastructure and public services.

The project showed mixed results when evaluated against the specific project objective *“to enhance the economic productivity and the quality of life within the Lima Metropolitan Region (LMR) through improving mobility and accessibility for the metropolitan population, especially in the peri-urban poor neighborhoods by establishing an efficient, reliable, cleaner and safer mass rapid transit system”* (PPAR:2015).

While Protransporte estimates that 80 percent of users come from poor neighborhoods, JICA 2013 found that when it comes to income distribution, only 7 percent of the users came under the poor income category of US\$280 or less (PPAR 2015:20-21)

Affordability issues caused the feeder route traffic volume to be less than expected, so in 2014 a tariff update incorporated a cross subsidy system vis-a-vis the trunk routes to enhance accessibility for the feeder route users.

A perceptions analysis conducted by the OVE (2015) indicated that despite the use of socio-economic targeting, access for the poor showed little improvement, with 48 percent of the very poor and 40 percent of the poor that use other public transport, reported that the Metropolitano BRT did not connect them to the locations they needed to reach in the city (PPAR 2015:23). In its conclusions, the PPAR accepted that while the Metropolitano BRT was able to provide mobility to a significant number of poor residents, it is not likely to reach its potential for serving this population segment without extensive penetration of feeder routes with multiple modes, to their work, school, hospital and residential locations (ibid:33).

The problem was that progress on integrating transport lagged, as the rationalization bus routes was cancelled due to lack of data, the *Study for the Consolidation of the Integrated Public Transport System* moved at a slower pace than expected, and the NMT (bicycle) infrastructure works suffered a lack of skilled consultants able to prepare engineering designs for bikeways, there were lengthy approval mechanisms and the construction industry had a limited interest in bikeway works.

OVE (2015) listed some recommendations on improving access¹¹⁴ and Protransporte is actively engaged on a series of these measures :

- Increasing the reach and frequency of feeders and integrating BRT with existing informal or traditional modes to provide cost-effective and flexible service in lower-density neighborhoods and hard-to-reach hilly areas. These types of services, operating informally and according to demand, can play an important role as both feeders to BRT and complementary services in lower-demand corridors and peri-urban spaces where large buses cannot operate.
- **Providing better connectivity and integration between BRT and Metro to increase access to high-speed transit in the city.** Expanding trunk lines and feeder services and integrating them with new Metro lines, job centers as well as other activity centers could create an intermodal mass transit network that could improve the utility of BRT in poor areas.
- **Targeting subsidies to low-income BRT users, in part to counter a resurgence of the competing informal transit sector.** Integrated fares and reduction in transfer costs can improve affordability of the system, but high overall fares can also drive down demand. When evaluating subsidies and increased coverage of BRT, governments should take into account positive externalities from increased usage, such as reductions in congestion, pollution, and accidents.

12.8. Case Analysis: Implementation Experience

The early problems of low ridership indicates the need to allocate resources to support post-operational costs and fund a marketing budget until viable ridership levels are reached. Passenger/revenue risks placed on the operators need to be manageable and government should take some responsibilities to ensure financial sustainability.

The project experienced delays and resultant cost increases. This was attributed to changes made after final engineering designs had been completed; the devaluation of the dollar, a worldwide increase in the price of key construction inputs such as steel, cement and fuel. High project administration costs due to the complexity of contracting and the longer implementation period, was also a factor, among others.

Local institutional capacity needed time to grow, emphasizing the need for early capacity building and skills development. It took time for Protransporte to be able to manage a complex project after initially being created as a Project Implementation Unit. The support of the mayor helped resolve these issues over time.

There was confusion on the standard of Environmental Assessment (EA) used, resulting in community protests. The inspection panel found that the initial studies did not comply with policy in terms of identification, analysis and mitigation of impacts beyond the corridor itself, e.g., changes in pedestrian and vehicular traffic flows and their economic and cultural impacts in the District of Barranco.

The bus scrapping program added another layer of complexity to an already challenging project. Uncertainty about bus scrapping and lengthy project restructuring caused a 3-

¹¹⁴ OVE (2016) Urban Transport and Poverty: Mobility and Accessibility Effects of IDB-supported BRT Systems in Cali and Lima

year delay and distracted efforts and resources from grant implementation¹¹⁵. MML changed its mind several times on how to proceed with the scrapping of old buses, thus delaying project implementation¹¹⁶.

Legal conflicts and contract issues also caused delays and had repercussions. Failure to have the necessary components in place such as infrastructure and land acquisition, prior to entering into contracts with operators left the city open to contract breaches. This indicates that operators bore substantial risks, for which they then sought redress in the courts.

It was reported in Peru Reports¹¹⁷ that a bus company has won a \$15 million claim against the city of Lima for breach of contract due to its late opening of the BRT, its failure to extend the network to the northern suburb of Carabayllo and its failure to remove competing private bus routes from Lima's streets. MML faces seven other breach-of-contract cases related to the Metropolitano transit system from fare collector ACS Solutions, natural-gas fuel provider PGN and bus operator Transvial. The estimated total liability due to the city's Metropolitano contracts was at \$170 million (MML's annual budget is \$380 million).

12.9. Case Analysis: Lessons Learned

- **Low ridership can inflict an early financial burden.** Resources need to be allocated for post-operational costs and marketing until viable ridership levels are reached.
- **Tariff policy may need to be better tailored to affordability.** This may not necessarily mean adjusting the benchmark flat rate, but using methodologies to adjust fares in respect of affordability for specific groups. Surveys found that generally the BRT users (46 percent) felt that the price of using the system is either economical or very economical. However, 35 percent of the very poor were more likely to rate the system as not affordable¹¹⁸. There was also an aspect that reliability and safety were highly regarded, serving as a line of reasoning to justify the higher cost.
- **Lack of community consultation can impact severely on the project.** Insufficient information was provided to residents, resulting in a complaint and an Inspection Panel investigation, which contributed to implementation delays. Greater involvement of project affected persons will prevent community opposition and disputes over environmental and social impacts.
- **Fleet renewal is a complex affair, which needs strong political support, funding and working with affected parties.** Removing bus scrapping from the project's critical path is a lesson to be learned.

¹¹⁵ Due to the changes and indecision regarding the bus-scrapping mechanism, a decision on project restructuring was only possible during the Midterm Review. Although this eventually allowed the GEF Project to move out of its impasse, it took nearly three years for restructuring to be completed.

¹¹⁶ IEG WB: (2015) Project Performance Assessment Report Republic of Peru LIMA TRANSPORT PROJECT

¹¹⁷ <https://perureports.com/lima-to-pay-15-million-settlement-over-bus-rapid-transit-contract/3349/>. Article Updated: February 24, 2016

¹¹⁸ OVE (2016). OVE's affordability analysis found that low-income public transit users living within the area of influence of the BRT system spent over 20% of their income on public transport, more than double the 10% threshold that many experts define as affordable.

This page intentionally left blank

Part 3. BRT Design Considerations

This page intentionally left blank

13. Introduction

Part 2: BRT Case Studies reviewed the selected Bank-funded BRT project cases in fifteen cities, documenting a synthesis of successes and lessons learned, which can be instructive to cities planning BRT.

This section, **Part 3: BRT Design Considerations** summarizes learnings on numerous design aspects, implementation and performance of BRT, based largely on the experience of the case studies but also addresses common design issues and deliberations. While it may lack the 'ready-answers' that some seek, it strives to provide ample insights and guidance on how to approach the decision-making process. It also seeks to de-mystify BRT so that essential foundational principles are clarified.

This section is structured into topical areas, based on the themes and issues that arose during the case studies review, while understanding that many overlaps occur. In some cases, we draw on cities outside the scope of this report to illustrate specific issues. Where there is no opportunity to delve into deeper discussion on a specific area, opportunities for further research arise.

The authors offer some considerations on planning and implementing BRT systems in developing countries. These considerations and recommendations are exclusively derived from the authors' experience and research and only represents the authors' views.

A reference list is included at the end of this section for readers to delve deeper into specific areas if so desired.

This page intentionally left blank



14. Practical Insights into BRT Applications

BRT holds substantial promise for cities as they aspire to improve urban transport conditions. In some cases, cities have been able to progress from existing chaotic public transport to a more orderly and respectful public transport system. Substantial benefits can be realized from BRT in terms of travel and cost efficiency, improved safety, environmental outcomes and quality of life.

This section identifies three recurring and overarching themes from the BRT case studies and research, being 1) the BRT 'brand', 2) being practical and realistic on BRT passenger carrying capacity, and 3) understanding the political dimension. Section 15 elaborates on the specific themes and lessons related to 'software' elements of BRT, such as institutions, operations management, financial sustainability; and Section 16 considers the 'hardware' such as busway and station design etc. and operations design of BRT.

Section 14	Selected Overarching Themes
Section 15	The Software of BRT: institutions, management, sector reform, financial sustainability
Section 16	The Hardware and Operations Design of BRT

The key points from Section 14 are:

- BRT has proven to be a key intervention to address the urban mobility issues that cities face but should be applied as part of the urban mobility toolbox, employing an integrated set of measures, and with a flexible design approach suitable to local conditions and context.
- Planners should be vigilant not to 'over-promise' and to avoid optimism bias. Exporting BRT 'success stories' without understanding unique local conditions creates a focus on 'building a BRT' that becomes too infrastructure-centric. Planners need to consider local conditions, affordability and understand the local forces at play.
- Higher capacity BRT systems with scaled-up infrastructure can deliver a high passenger throughput comparable to a Metro (at a significantly lower cost). However, as BRT is placed within built-environments, physical constraints often impose a limit on capacity, and quality suffers when these thresholds are breached.
- Developing BRT in a complex urban environment means that BRT projects have a strong political dimension. The 'why', 'what', and 'how' of the project must be clear and be in alignment with the city's agreed transport and mobility objectives. Developing a Strategic Planning Framework will generate greater local confidence ('buy-in') and ownership, ensure commitment and support during project implementation, and inform BRT design.
- The choice of rapid transit options should be needs-based and not technology-based. A proper alternative analysis is required, using a logical sequence so that the process is transparent and objective, and be able to compare benefits and costs.

14.1. Weighing up the BRT Brand - What it Represents

This section attempts to demystify some perceptions of what BRT is, drawing on experiences from case studies and research. The intent is to provoke deeper thought on the BRT applications in the local context, as each city has its own unique characteristics of social norms, demographics and varying transportation conditions and needs. Attention is drawn to five key features:

1. **BRT should not be a ‘standalone’ intervention, but be seen as one element of the urban mobility toolbox.** Urban mobility¹¹⁹ enables cities and their residents to flourish by providing universal accessibility to jobs, services, markets, and other socioeconomic opportunities that enhance quality of life.

BRT is not a ‘silver bullet’ solution for every city and corridor, but can be an effective solution which can adapt to the diverse and complex local environment that a city operates in. BRT is part of an Urban Mobility Toolbox (see Figure 14.1-1) which features an interplay of elements that contribute to *urban mobility and accessibility*, where public transit corridors (be it Rail or BRT) play a key role.

However, other cross-cutting solutions such as ‘Integrated Corridor Management’ (ICM) can be utilized. ICM is an example of a solution in the toolbox that is not necessarily BRT— but a set of measures designed and implemented together such as bus lanes and other bus infrastructure or service improvements, traffic management, road safety features, and biking and walking facilities. For lower demand corridors or for medium-sized cities, ICM can be a cost-efficient alternative to addressing current public transport needs while setting up the stage for future mass transit interventions when conditions are ready (Section 16.9).

Figure 14.1-1: The Diverse Elements in the Urban Mobility Toolbox

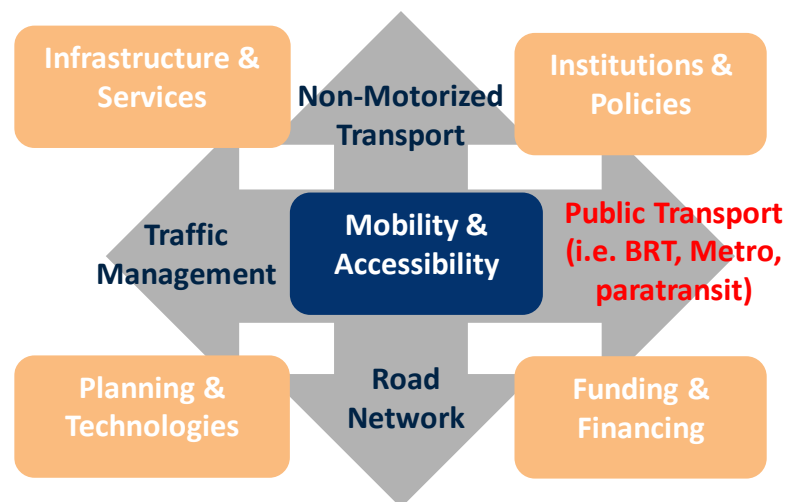

Source: WB Urban Mobility GSG Back to School, World Bank, 2019

2. **BRT is not just a high-quality rapid transit infrastructure.** As discussed further in Section 14.3, for BRT to be successful, design should be based on ‘*agreed objectives*’

¹¹⁹ Pulido, Daniel, Georges Darido, Ramon Munoz-Raskin, and Joanna Moody, editors. 2018. *The Urban Rail Development Handbook*. Washington, DC: World Bank. doi:10.1596/978-1-4648-1272-9. License: Creative Commons Attribution CC BY 3.0 IGO

which ultimately must focus on user needs, such as: improvements to accessibility, safety, security, and other benefits to persons who need it the most, and at the same time unlocking other potential benefits from economic growth and agglomeration. However, if such megaprojects are not planned and designed with sustainable development in mind, they can impose a large financial burden on governments with limited resources¹²⁰. Section 14.3 outlines the four ‘A’s – *Availability, Accessibility, Affordability, and Acceptability*, and these need to be defined according to practical indicators such as walking distance, mode share, and waiting times, among others (ibid).

3. **BRT is not a standard solution; it requires careful planning and design, and planners must understand the principles of BRT and WHY IT WORKS!** When designing BRT, planners should be mindful of not ‘zooming in’ on a too-narrow perspective, or attempting to replicate successful examples from elsewhere without adequate analysis of local conditions and risks. Such an approach, often relying on international consultants who may not be well versed in the local intricacies can become overly focused on the infrastructure, while glossing over the difficulties, particularly the ‘software’ components which are often more challenging than the infrastructure-build. The experience in case study cities has seen lengthy project delays due to the lack of appreciation of risk and unique local challenges (Hanoi, Dar es Salaam, Accra). Planners and designers need to conduct an honest assessment of the city’s knowledge base and capacity, and if needed, allow a reasonable path and the time to tap into existing institutions and grow BRT practitioners. Prioritizing capacity-building as a first intervention, proved to be instrumental in the success of Indian cities and Lagos.

It is important for planners not to over-promise and avoid optimism bias. Clear objectives-based planning is needed.

4. **BRT represents an integrated set of measures and offers a range of design options for both infrastructure and operations.** Characteristically, BRT aims at improving the standard of road-based public transport, with quality infrastructure and high-frequency services to promote substantial ridership, supported by technology advancement, institutional framework, and other business and policy elements. The case studies consistently demonstrated BRT as a key intervention to address the urban mobility conundrum that cities face.

BRT also has the flexibility to adapt to city conditions, balancing intricate interplays with other road-based transport modes and users, institutional structures, technology applications, and the political dimensions.

5. **BRT infrastructure can range from low-cost infrastructure (‘lite’) that offers operational enhancements (sometimes with lower capacity) to more sophisticated high-capacity infrastructure.** Table 14.1-1 illustrates this from an infrastructure perspective. The type of operations can also vary, being either trunk-only or with services deviating off the busway (pre-trunk ‘through-services’ referred to as a

¹²⁰ Pulido, Daniel, Georges Darido, Ramon Munoz-Raskin, and Joanna Moody, editors. 2018. *The Urban Rail Development Handbook*. Washington, DC: World Bank. doi:10.1596/978-1-4648-1272-9. License: Creative Commons Attribution CC BY 3.0 IGO

‘direct service’). This allows better accessibility and gives BRT a wider ‘urban footprint’ and creates a more holistic network. But the choice of operating system is not to be regarded as an ‘either/or’ choice; as BRT design can blend various features to satisfy the ‘agreed objectives’ developed in conjunction with the city. Nonetheless, BRT still represents a major investment cost for a city, perhaps far more expensive than if the city implemented a range of integrated bus priority measures which could still produce, to a lesser extent, significant aggregate benefits.

Table 14.1-1: The Range of BRT Infrastructure

	Stations	Running Ways	Service Plan	Vehicles	Systems
Rapid Bus, “BRT Lite”	“Super” stops with shelters	Some dedicated lanes, Mixed Traffic, Queue Jumpers	Trunk/ Feeder: All-Stops Trunk Line	Buses with Unique Route Numbers, Head signs, livery	Next bus information at stations, IC/phone fare collection
High, Quality, Capacity (e.g., Bogota)	High Platforms, P/R, Amenities, Services	Fully dedicated running way, partially grade-separated	Combo.: All-Stops; On-Line Expresses; Integrated Feeder/ Trunk	Hybrid electric; Guided; Specialized Vehicles	Central Control Room, TSP, CAD, Off-board/ efficient fare collection

Source: LUTP Training, Zambia, 2019

BRT also requires a capable institution, effective in taking charge of complex project management and coordination throughout planning, design, build and operations. Success also depends on a sound business model, proper funding mechanisms and prudent risk management, and the use of technology to maximize customer benefits and operations efficiency.

The early development and success of Latin American BRT systems has been a point of reference for cities. However, the BRT case reviews have shown that in actual experience, their successes were tempered with unexpected challenges. *One key reason is that in following Latin America’s successful ‘template’, planners have given insufficient attention to, or failed to understand local forces at play, local context and environmental conditions.*

14.1.1. Case Analysis: Lagos BRT Lite – Clear Design Objectives

Lagos BRT is an ideal demonstration of ‘form following function’ and building ground support for scaling-up in the future. One feature of the curbside Phase I BRT Lite success in Lagos, was to allow flexibility in the design, setting reasonable (albeit lower) targets, commiserate with the environment where regulation was lacking, and capacity low in planning and investment. Additionally, Lagos launched well-thought out, and early public engagement to agree on the BRT objectives.

While Lagos BRT still faces challenges, it was successful in achieving high ridership and financial sustainability; both being key performance indicators.

14.1.2. Case Analysis: Criticism of Hanoi's BRT design

Hanoi's design adopted a trunk-feeder system common in Latin America - but has drawn criticism for failing to comply with full-scale, gold standard BRT (such as in Guangzhou)¹²¹. Such criticism is unwarranted because (1) prescriptive 'BRT standards' do not take into account the specific conditions and needs of the city; and (2) any comparison between Guangzhou and Hanoi's BRT is irrelevant as road widths and operating environment differ greatly, as shown below. *Passing lanes would improve capacity, but at what cost if land acquisition comes into play?*

Figure 14.1-2: Guangzhou BRT



Source: Far East Mobility

Figure 14.1-3: Hanoi BRT



Source: Hanoi Times

14.2. Being Practical on BRT Capacity

BRT carrying capacity is usually measured as passengers per hour per direction (phpd) throughput at *a single point (screen line)*, however **the single-point capacity does not represent the practical carrying capacity of the whole corridor in day-to-day operations.**

Typically, the practical carrying capacity of a BRT corridor will max out at around 10,000 passengers phpd¹²², limited by choke points in the system such as bus berths at stations and intersections. An example is in Dar es Salaam where despite a reported peak capacity of 18,000 passengers phpd at a single point¹²³, the geometry and station constraints on the CBD main line to Kivukoni terminal effectively limits the carrying capacity to less than 7,000 passengers phpd. Larger BRT systems have demonstrated higher capacity corridors that are comparable to Metro Rail systems (e.g. Bogotá, Istanbul, Guangzhou); however, such high capacity systems are outliers. Cervero (2013) found that *“in practice, BRT's carrying capacity is lower, from 2,000 to 8,000 (passengers phpd)¹²⁴*. In most cities, BRT corridor capacity does not exceed 10,000 passengers phpd, and researchers at Cape Town reported that when passenger numbers on MiCiti BRT exceeded 9,300, bus congestion began to cause 'knock-on' effects throughout the system¹²⁵.

¹²¹ Nguyen. MH. Ha TT. Tu. SS & Chuong, T. (2019): Impediments to the bus rapid transit implementation in developing countries – a typical evidence from Hanoi, International Journal of Urban Sciences, DOI:10.1080/12265934.2019.1577747 Last accessed 22/03/2020

¹²² Reference to carrying capacity in this section is therefore based on practical capacity, and not capacity at a single point screen line.

¹²³ BRT Global data

¹²⁴ Robert Cervero (2013). Bus Rapid Transit: An Efficient and Competitive Mode of Public Transport, Institute of Urban Regional Development, Berkeley

¹²⁵ Presentation by Herrie Schalekamp UCT 16 June 2016

Systems with a corridor capacity exceeding 10,000 passengers phpd would demand a very different infrastructure level, which many cities will not be able to achieve. Hidalgo et al. (2012) stated that: “these high capacity systems also require a much scaled up infrastructure, such as multiple platforms at stations, overtaking lanes, level boarding, prepayment, large buses with multiple doors, express and local services, and traffic engineering measures at intersections, allowing for very large passenger throughput thus being able to reach an actual throughput of 43,000 passengers per hour per direction with average bus occupancy of 150 passengers per articulated bus, and a commercial speed of 22–24 km/h”¹²⁶.

14.2.1. Case Analysis: TransMilenio’s High Capacity and User Experience

A WRI report in CityFix (2011) on TransMilenio stated that: “At peak hours, stations are uncomfortably crowded for passengers. People crowd around both the entrances and exits of the buses, making it nearly impossible for users to depart the bus at rush hour. Passengers at stations refuse to give right-of-way to exiting bus riders, creating stressful bottlenecks. It’s common to miss one’s stop because of the difficulty in exiting the bus. TransMilenio can currently serve up to approximately 45,000 passengers per direction per hour—a figure competitive with Metro lines in Mexico City and London”.¹²⁷

While TransMilenio has taken BRT capacity to its design limits, it faces complex operational challenges associated with a strong ridership¹²⁸. Public discourse¹²⁹ and comments¹³⁰ have pointed out some issues including that delays in expansion have limited the system’s capacity to respond to its impressive demand growth, and that TransMilenio’s route network is unnecessarily complex with a large number of routes (regular and express services) along a single corridor making its use challenging for commuters.

Figure 14.2-1 TransMilenio (rush hour)



Source: BRT Centre of Excellence

Figure 14.2-2: TransMilenio (rush hour)



Source: Roberto Vargas, El Tiempo.com

¹²⁶ Hidalgo D, Lleras G, and Hernández, E. (2012) Methodology for calculating passenger capacity in bus rapid transit systems: Application to the TransMilenio system in Bogotá, Colombia. Source: <https://www.worldtransitresearch.info/research/4468/> Last accessed 04/07/2019

¹²⁷ Cityfix WRI Hutchinson, A. (2011) *TransMilenio: The Good, the Bus and the Ugly*. Last accessed 22/05/2019

Source: <https://thecityfix.com/blog/transmilenio-the-good-the-bus-and-the-ugly> Last accessed 22/05/2019

¹²⁸ This Big City (2012) Source: <http://thisbigcity.net/has-bogotas-transmilenio-become-a-victim-of-its-own-success/> Last accessed 2/10/2019

¹²⁹ Professor Guillermo Ramirez *Why doesn't TransMilenio work?* Report in: <https://thebogotapost.com/bogotas-transmilenio-system-a-painful-route-to-the-future/1177/> Last accessed 04/07/2019

¹³⁰ Discussions on <http://blogs.worldbank.org/transport/impacoevaluations/comment/reply/671> Last accessed 15/05/2019

14.2.2. Capacity Considerations: BRT vs. Metro

At a level of 10,000 (or even 15,000) passengers phpd for a corridor, Metro rail would not be financially viable, demonstrating BRT's effective niche in the mass transit market. On this basis, BRT and Metro cannot be accurately described as 'competition' or as an 'either/or' proposition. It shows BRT as being ideally placed to build up corridor demand in the medium term to support LRT/ MRT investment in the long term, mindful that BRT and LRT/Metro can complement each other in an integrated public transport network.

Research has suggested that a switching point exists in developing countries where BRT may have competitive OPEX costs for moving up to 25,000 passengers phpd and Metro may have comparative advantages above that value¹³¹. The switching value may be lower for developed countries due to labor and other costs. However, this is a financial reckoning and may not be reflective of practical and other realities.

Rapid transit projects may be among the largest transport investments ever made in a city or metropolitan region and represents large and essentially irreversible outlays of investment capital on long-term assets in complex, interconnected, and uncertain urban systems¹³². It is therefore critical to evaluate and compare the potential benefits and costs of alternative investments when planning the transportation system (network) and its corridors.

What is apparent, is that the choice should not be technology-driven, (rail or bus) but be 'needs driven'. Serious alternatives analysis is required which considers corridor characteristics (section width, urban form), passenger demand, integration and connectivity, and funding and financing capacity. For a new BRT, planners should consider the practical limit to the BRT capacity threshold at which it can maintain an acceptable or appropriate quality of service¹³³.

The Urban Rail Development Handbook (2018: Ch 3) describes the planning sequence and alternatives analysis for a Rapid Transit system. The logical six-step sequence, shown in Figure 14.2-3 is intended to help direct decision makers to develop their projects in a transparent and objective way, while still providing flexibility to tailor the process to local conditions.

¹³¹ Montassar DRAIEF-SYSTRAL (2006) Source:

<http://siteresources.worldbank.org/INTTRANSPORT/Resources/336291-1122908670104/1504838-1157987224249/4SYSTRAL2.pdf> Last accessed 22/03/2020

¹³² Mitrić, Slobodan. (1997). *Approaching Metros as Potential Development Projects* (TWU-28). Washington, DC: World Bank.

¹³³ 'Quality of Service' is not an absolute term; it can be a level of quality that the city defines, but from a passenger perspective, respect, safety, and comfort would be important qualifiers.

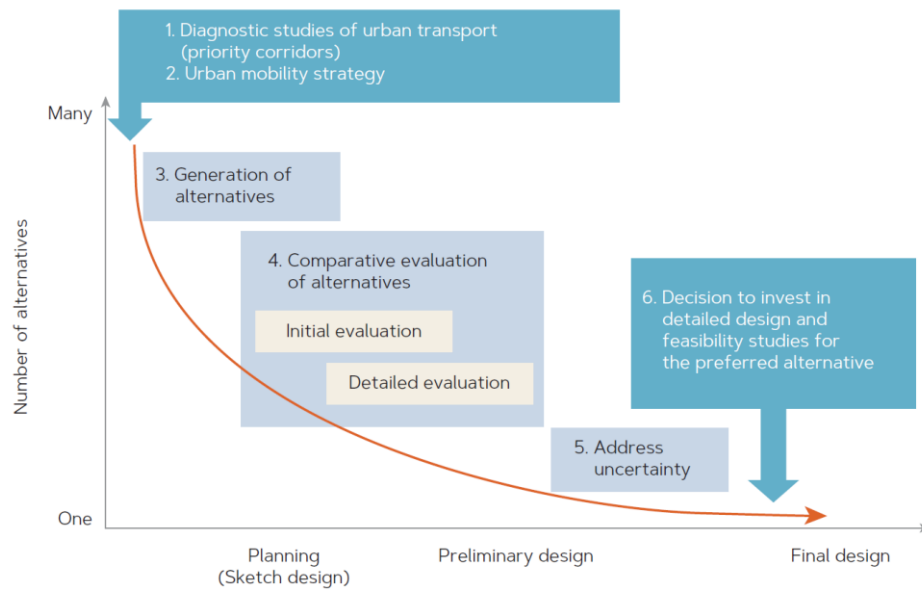
Figure 14.2-3: Six-Step Sequence for the Rapid Transit Alternative Analysis

Source: *The Urban Rail Development Handbook*, World Bank, 2018

14.3. Understanding the Political Dimension

14.3.1. Securing Political Commitment

Strong political leadership has featured in a number of the successfully implemented BRT projects, and their successes can be attributed to having good political and technical support. But, as stated by Turner et al. (2012:18), relying on a ‘political champion’ over the long term, could be somewhat counterproductive, citing the Bogotá experience, where an opposition party was elected - and it was not keen to support a project tied so closely to the previous administration¹³⁴.

However, not to be overlooked is the political support (and stakeholder support) that comes from having confidence in the project. Decision makers, who are vested in the project and are self-assured in taking the lead, are more prepared to make necessary decisions and accept some risk. In Hanoi, despite strong initial commitment by HPC, its leadership wavered in its confidence in the BRT system over the course of its implementation. This consequently delayed key decisions and caused many eventual problems and sometimes led to acrimonious relationships. Interestingly, a study tour to view model BRT cities (Curitiba and Bogotá) did not improve confidence or dispel concerns; it amplified to the participants the risks in trying to emulate such systems into the Hanoi context. This highlights the importance of aligning study tours to clear objectives and specific interests.

Extended delay in BRT implementation becomes a vicious cycle impacting on commitment and support. BRT case study projects averaged seven years to complete and took years to further develop a network, so the city’s ownership and commitment

¹³⁴ Turner M. Kooshian C. Winkelman S. (2012) Case Study: Colombia’s Bus Rapid Transit (BRT) Development and Expansion. An analysis of barriers and critical enablers of Colombia’s BRT systems. Center for Clean Air Policy. Produced for the Mitigation Action Implementation Network (MAIN)

needs to be ongoing. India's case studies showed that project delays exacerbated the problem of weak local technical skills, as staff turnover increased and key decision-makers supporting the project transferred, causing further delays. In Hanoi, staffing changes, negative publicity, and uncertainty in the project completion time all added to the project's difficulties. Rizvi & Sclar (2014)¹³⁵ make an excellent analysis of Delhi BRT and Ahmedabad BRT *highlighting the importance of the planning process and project timing being instrumental in defining project outcomes.*

14.3.2. Developing a Strategic Policy Framework

Agreeing on objectives is a crucial early step to rally political support and commitment. Objectives should be clear and defined (and if possible, measurable), being a statement of what the project is designed to achieve. Agreed objectives can serve as a first layer of agreement across a range of stakeholders. Agreed objectives can also serve as a useful 'point of reference' should any disagreements occur during planning and design stages.

Agreed objectives can incorporate social objectives as well as system design objectives (which in 'best practice' would align with social objectives). Gomide, Leite, and Rebelo (2004)¹³⁶ list four key attributes of a rapid transit system that, if incorporated in design and planning, can catalyze sustainable and equitable development. These are known as the four 'A's, being from the user's perspective:

- **Availability** - namely connectivity and coverage, particularly to lower-income areas.
- **Accessibility** - meaning ease with which an individual can access opportunities such as jobs, health care, education, and others .
- **Affordability** - referring to the financial and opportunity-cost burdens that households experience on account of travel costs. A system that relies on fares to recover all operating costs may price out lower-income users who rely most heavily on these services.
- **Acceptability** - referring to the quality of urban rapid transit infrastructure and service for the user, including comfort, safety and security, and reliability.

Bogotá and Lagos, while worlds apart in distance and characteristics of BRT, both exhibit a clear objective-driven planning process, with social improvement objectives at the forefront¹³⁷. Both systems were designed in accordance with locally identified needs and completed the projects successfully in chaotic transport environments, while at the same time dealing with considerable vested interests. Both cities were able to establish high-caliber urban transport agencies in charge of BRT development and management.

Such an objectives-driven approach is unfortunately not widely practiced. BRT is frequently promoted through international BRT examples and glossy 'before and after' renderings, with an offer of technical support, access to loan funds, where benefits are

¹³⁵ Rizvi A. & Sclar E., (2014), "Implementing Bus Rapid Transit: A tale of two Indian cities", in Research in Transportation Economics. Source: <https://www.sciencedirect.com/science/article/abs/pii/S0739885914000845> Last accessed 2/10/2019

¹³⁶ Gomide, Alexandre, Sabina Leite, and Jorge Rebelo. 2004. Public Transport and Urban Poverty: A Synthetic Index of Adequate Service. Washington, DC: World Bank. <http://documents.worldbank.org/curated/en/804921467998799407/Main-report>.

¹³⁷ Under Mayor Peñalosa the stated focus was on creating a more egalitarian society, improving quality of life income levels, increasing productivity, and reducing congestion, all of which entailed reducing the emphasis on investment to support private automobiles.

often inflated, and costs tempered. *However, successful outcomes rely on aligning the project with broadly supported mobility objectives of the city.*

However, system design objectives should not be abstract. They should be elaborated to include practical design concepts which achieve sustainability or enhance user experience, being for example infrastructure that delivers commercial operating speeds and efficient travel time, traffic treatments that allow highly frequent services, and safe, secure and comfortable passenger facilities to improve quality of service.

In managing these decisions, local decision-makers should be fully conversant with the ‘why, what and how’ of the project through a strategic policy framework to guide the decision-making process. Local buy-in and project ownership come from a clear understanding of how objectives and strategies translate into actions, outcomes and project definition. This will improve commitment and on-going support during project implementation. Figure 14.3-1 sets out an example of such an overall **strategic policy framework**. This framework starts with setting the ‘agreed objectives’ which sets a platform for the strategy/policy which then materializes in specific plans and actions.

Figure 14.3-1: Example of a Public Transport Strategic Policy Framework

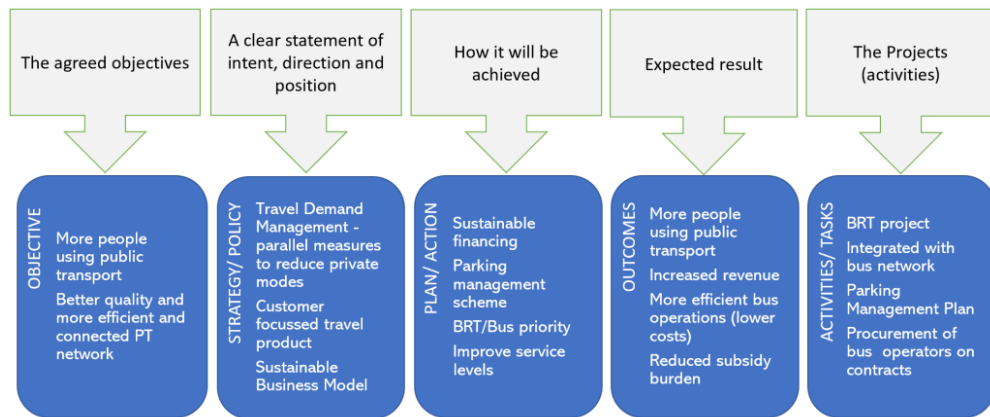

Source: Frits Olyslagers

14.3.3. Managing Political Risks

Implementation risks are often political risks. Table 14.3-1 outlines common political risks and suggests potential mitigation plans. In any risk appraisal, it is particularly important to acknowledge and consider all viewpoints, including those from opposing stakeholders, and not just respond with a prescribed remedy or a BRT ‘sales pitch’ to allay concerns. Understanding and consulting with opposition groups may uncover valid concerns that need to be addressed.

Table 14.3-1: Political Risk Analysis and Mitigation

Potential Political Risks	Potential Remedies and Considerations
NIMBY (NOT IN MY BACKYARD) where the system planning encounters resistance from property owners	<ul style="list-style-type: none"> ▪ Consultations, information, socialization during preparation. ▪ Manage an honest and transparent process for all stakeholder inputs. ▪ People oppose details, not an entire project (but if people's concerns are ignored, opposition is to entire project).
NIMRS (NOT IN MY ROAD SPACE)- where 'car is King', and BRT is seen as disrupting or worsening traffic.	
Opposition from existing operators <ul style="list-style-type: none"> ▪ Disruption to the status quo ▪ Fear and uncertainty ▪ Distrust of Government ▪ Feeling vulnerability in their livelihood 	<ul style="list-style-type: none"> ▪ Consultations, information, socialization, dialogues with operators. ▪ Work with operator associations and leaders. ▪ Where possible, ensure bidding process and operator selection is inclusive of existing players where they can meet requirements. ▪ Government to facilitate and find suitable PPP mechanisms and manage entry barriers. ▪ Unbundling fleet acquisition and bus operation is one method.
General opposition to project details	<ul style="list-style-type: none"> ▪ Consultations, information, socialization. ▪ Understand and differentiate between political and technical issues. ▪ BRT can be adapted to political reality

Source: WB Urban Mobility GSG Back-to-School, 2019

This page intentionally left blank

15. The Software of BRT – Institutions, Operations Management, Financial Sustainability

This section outlines the ‘soft’ elements of BRT which are critical to the implementation and operation of BRT, being more influential on the success of BRT than infrastructure.

Section 14	Selected Overarching Themes
Section 15	The Software of BRT: institutions, management, sector reform, financial sustainability
Section 16	The Hardware and Operations Design of BRT

Key points from Section 15 are:

Developing institutional capacity must in line with the conditions of the city and the scale of the project. Establishing and equipping an Urban Transport Authority (UTA) to manage a large BRT infrastructure project, and in parallel managing a major transport sector reform, may be expecting too much. Harnessing coordinating mechanisms that already exist could be a better option.

- The specific type and function of the UTA or agency needs to be defined, whether it has a regulatory or management function. Management capacity of the agency needs to be robust, mindful of the risk/power relationship with the private-sector operators as this will govern its level of control over operator performance and behavior. Typically, these organisations will grow organically as the system develops.
- Bus operator contracts are not standard models. Contracts must consider the capacity for risk management and the skill and experience of the players. Transitioning to new contract models presents a difficult challenge, requiring a committed and inclusive effort by the city – particularly to ensure contracts are adapted to local conditions.
- BRT has the potential to spearhead sector reform, to formalize and professionalize the industry, and are often necessary to support the BRT. Preparatory work to adapt the industry to new practices should start early (if not prior) to the project. It is not advised to use BRT simply as a leverage for reform, as it requires holistic management of the high number of risks involved.
- Fleet renewal programs have a useful role in bus reform to reduce aged fleets and avoid excess supply, but the program needs clear objectives, and if possible, it should be de-linked from the critical path of BRT implementation.
- BRT financial self-sufficiency is a challenge due to inelasticity of fares (affordability) and higher costs associated with BRT operations and sector formalization. Consequently, a proactive business approach and funding support is needed to achieve short and long-term financial sustainability, for infrastructure and service delivery.

15.1. Developing BRT Institutional Capacity

Institutional capacity plays an essential role in the successful implementation and operation of a BRT, yet this has proved a problematic area for many cities. The institutional aspects of BRT are more likely to be instrumental in the success of BRT than infrastructure. Flawed design in BRT infrastructure can reduce a systems effectiveness - but nonetheless improve bus priority, image and efficiency; *but a weak or botched institutional framework could see the system fail*. The case studies have been both informative and instructive in highlighting real and potential issues that cities face in developing their institutional capacity.

The studies have shown that institutional capacity of the public sector in terms of technical and management skills, must be commensurate to the situation of BRT. There has not always been enough capacity in the public sector to properly manage complex areas such as designing and implementing concession contracts for operations and ITS, and dealing with sector reform.

15.1.1. Establishing an Urban Transport Authority (UTA)

Cities typically employ a range of institutions to manage transport and traffic; however, their roles and functions are often fragmented and uncoordinated, both in budgets and operations.

To upgrade its public sector capacity, some cities opt to establish a UTA or similar agency to consolidate policy, improve coordination of transport management and lead the implementation of BRT, or manage its planning and operations. Johannesburg placed this responsibility within the city itself, demonstrating that alternatives exist, appropriate with the conditions of the city. A clear lesson has been that such capacity development should happen prior to, or very early in the BRT program.

UTA's can represent different functions, but at a basic level, a set of core requirements should be met, as shown in Figure 15.1-1.

Figure 15.1-1: Core Requirements in Setting Up a UTA



Source: Wenyu Jia, World Bank

However, a new UTA takes time to mature and adjust during its transition stage and when undergoing planning, implementation and operations. If it is newly established it will not be sufficiently equipped, facing a considerable learning curve, and will need time to establish its authority and influence. In the case study cities, planned UTAs either were not realized (Hanoi and India cities¹³⁸), or were not sufficiently robust as a political, regulatory or coordinating entity to undertake implementation of a major sector reform in parallel with a BRT implementation (Accra), or the new BRT agency lacked the strength to match influential power players (Dar es Salaam).

Lessons can be learned from Colombian and Indian cities, where central government programs provided technical assistance and funding, while municipalities formulated projects. In the case of Lagos, LAMATA already gained some experience in urban road management and maintenance, and strategically prioritized a comprehensive capacity and skills development programs as a first intervention.

Experience suggests that in a low capacity environment, it might be better to harness or facilitate existing coordinating mechanisms to implement BRT. It may be possible to establish a high-level steering Committee with the key players, to take the strategic planning and coordination role, and give the implementation responsibilities to capable organizations with the proven skills and capacity.

15.1.2. Level of Transport Authority

The role and function of the authority/agency needs clear definitions, whether it is to serve at a high-level - responsible mainly for policy, planning, and regulation (LAMATA Lagos) or at a middle-level, managing BRT day-to-day operations, service planning, and the operator contracts (TransMilenio-Bogotá, Protransporte-Lima).

Figure 15.1-2 outlines a tiered shared-risk approach for strategic policy, business management and operations level responsibilities, and assigns risks accordingly.

Figure 15.1-2: Tiered Level of Functions and Risk Assignment Among Players



Source: Frits Olyslagers

¹³⁸ The establishment of Unified Metropolitan Transport Authorities (UMTA) is included under in the National Urban Transport Management Policy and alluded to in the Project Appraisal Document (PAD 2009) for SUTP project in Indian Cities under the category of key urban transport reforms. However, the PAD does not appear to directly commit to establishing UMTA as a key project objective.

A high-level transport authority, responsible for policy, planning and regulation is more effective in garnering cooperation, managing coordination and managing high-level decision-making necessary to implement BRT but is less effective in operating a BRT system. GAPTE in Accra acts in a high-level capacity, but is not adequately equipped to manage the QBS system and manage its financial risks. LAMATA (Lagos, Nigeria) also in a high-level role, assigns the daily management of the BRT to the operator.

A mid-level transport agency operates as a system manager, with responsibility for overall BRT service delivery; managing the operators and expanding the BRT network. The strength of this role is that the agency becomes ‘owner’ of the system and is fully responsible for its finances and day-to-day operational control. It makes decisions on levels of service, fare policies, and manages passenger information, operator contracts, and system maintenance. Figures 15.1-3 shows the functions of a middle-level BRT agency.

Figure 15.1-3: Typical Functions of a BRT Agency

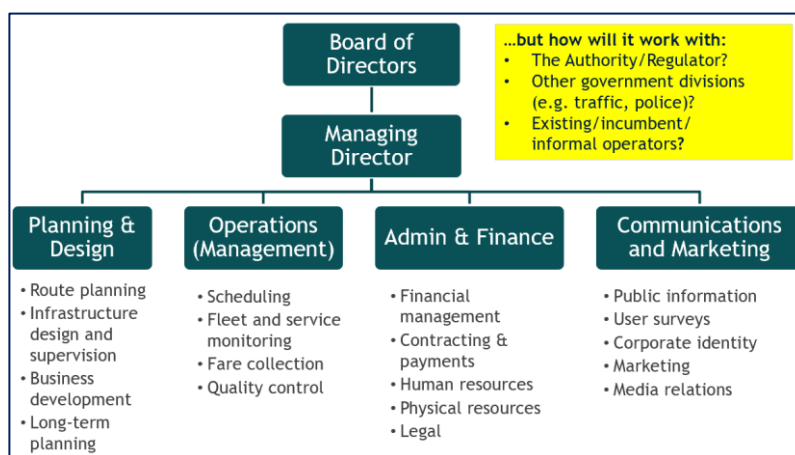

Source: 2019 Transport Forum, World Bank

Over time, the agencies will need to grow organically along with the system expansion and functional growth. Figure 15.1-4/5 shows the organizational development of TransMilenio S.A. over its successive stages.

Figures 15.1-4/5: Organic Growth of the TransMilenio Organisation

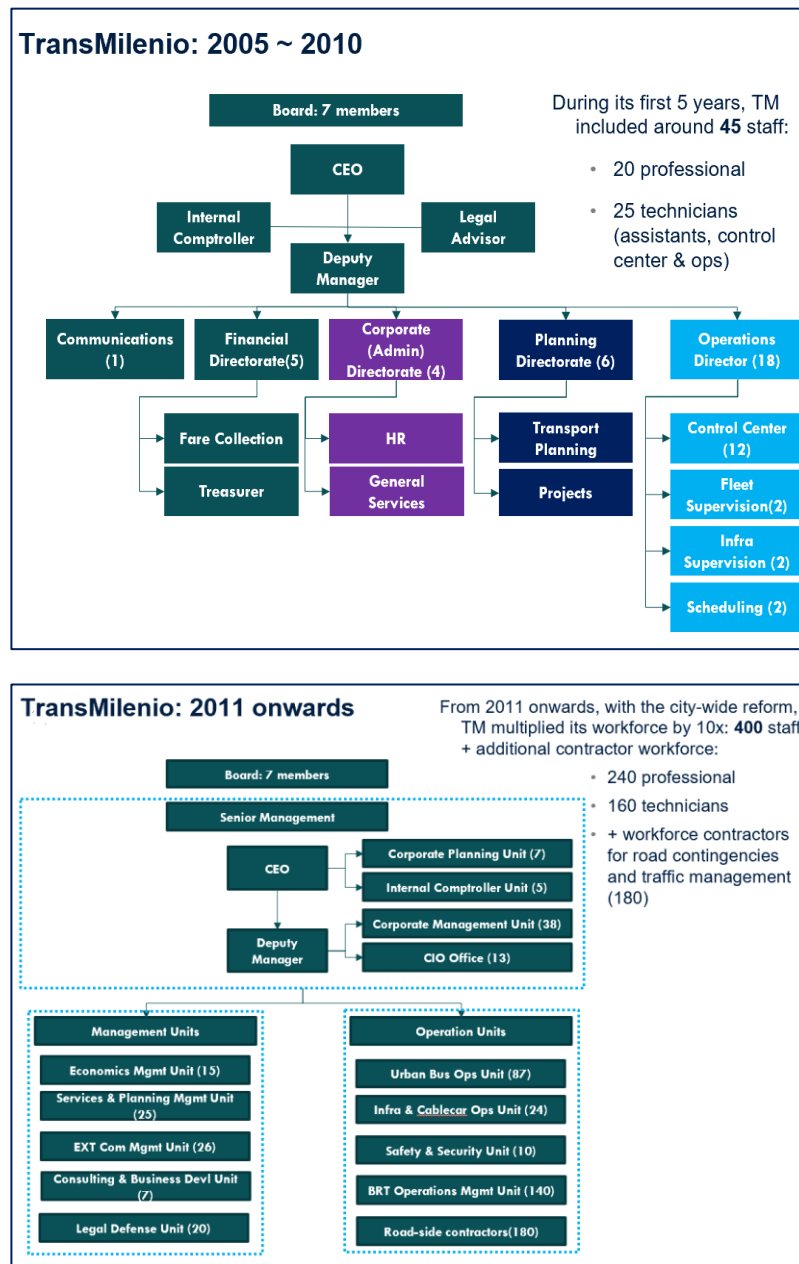

Source: 2019 Transport Forum, World Bank

15.1.3. Assigning Responsibility and Risks between Agency and Operators

The respective assignment of roles, responsibilities and risks between the BRT agency and operators will have an impact on the power relationship (and behavior) of the players. Increasingly, agencies are taking control over revenue and business risk as they are generally more able to set the rules and manage the risks of the operating environment.

Unmanaged risk or where the risk is inappropriately placed, can have a large impact on how the system functions. In **Bucaramanga** and in **Lima**, low ridership at the initial stages threatened the livelihood of the operators who were carrying financial risk which

they were unable to manage and threatened to terminate services. In **Dar es Salaam**, DART was intended to carry the business risk and operate on a commercial footing, but under pressure to implement the system it entered into an interim contract which transferred the revenue risk to the operator who then used its control over revenue to dictate the service levels, leaving DART in a weakened-position¹³⁹.

Getting the balance 'right' in risk sharing means assigning risks where they can be best managed. The main risk is always the commercial (financial) risk, sometimes called the 'revenue risk', which usually leaves one party carrying the burden over which they have insufficient control – impacting on behavior and performance. Ultimately the operator's contract will define the risk assignment between parties to influence behavior and performance as discussed in Section 15.2.2.

For this reason, the BRT agency needs a clearly defined and strong management role, with capacity to manage risk, and thus be able to exercise its control and authority over the system. It is also required to be a strong and capable partner in managing the bus operator contracts.

15.2. Securing Bus Operators

15.2.1. Understanding PPP for BRT Operations

In public transport, it is generally accepted that competitive private sector involvement delivers efficiency gains¹⁴⁰. However, PPPs - while generally positive – also present their own challenges.

A PPP can be defined as *"a long-term contract between a private party and a government entity, for providing a public asset or service, in which the private party bears significant risk and management responsibility, and remuneration is linked to performance"*¹⁴¹. The key qualifier is that some risk is taken by the private party , otherwise the contract would simply be for service provision.

The typical characteristics of a PPP are¹⁴²:

- (i) Value for money
- (ii) Risk transfer (clear assignment of risk)
- (iii) Output specifications
- (iv) Employing private sector skills and efficiencies
- (v) Payment through project revenues

¹³⁹ As discussed in Section 8 Dar es Salaam Case Study, the background of the problem lies in assurances made during planning which were not realized (such as securing an international bus operator) which placed DART under severe political pressure causing them to enter into a poorly designed ISP contract.

¹⁴⁰ Cain, A. Georges Darido, G, Baltes, M.R. Rodriguez, P., Johan C. Barrios, J.C. (2006) Applicability of Bogotá's TransMilenio BRT System to the United States FTA Report: FL-26-7104-01 Last accessed 22/03/2020

¹⁴¹ Public-Private-Partnership Legal Resource Center of the World Bank (PPPLRC) Source: <https://ppp.worldbank.org/public-private-partnership/overview/what-are-public-private-partnerships> Last accessed 22/03/2020

¹⁴² Source: Is the Public Transport PPP business booming? UIPT Summit 2019 Antonia Höög, Group Strategy Director, Keolis

At a macro level, PPP is generally seen as a way to bring finance, improve transparency with reduced corruption, enabling transfer of risk to the private sector at every stage of the project cycle, and at a micro level: efficiency that deliver cost and time savings (Rizzo:2017:150)¹⁴³. However, PPPs may not always be the best solution, and careful evaluation is needed as to their use and their structure. Cities should not assume that publicly-owned operations are inherently inefficient, where a PPP is the ‘silver bullet’ to achieve efficiency. PPP’s can cause a ‘power imbalance’ where risk and profit motivations surface, as in the case of Lagos Phase 1 and Dar es Salaam. For PPPs to be successful, requires a clear-headed analysis of risk, power, rights and obligations.

A reasonable argument can be made that if the ‘rules of the game’ are identical, *public entities operating under a performance-based contract can be as competent and efficient as the private sector*, particularly where the private sector is not well developed, or inexperienced. Cities who have engaged their experienced state-owned enterprises (SOE) in BRT, such as Hanoi and in China, consider them both competent and efficient; viewing privatization as ‘risky’¹⁴⁴. Also, if a system decides on having a single operator without competition, a public monopoly in the form of a SOE would be preferable to a private monopoly, as objectives between the parties are more readily aligned.

At a micro level, PPP’s are defined by detailed and binding contract obligations on roles, responsibilities and the assignment of risk. In the Colombian PPP model, the Authority/Agency controls infrastructure, and is responsible for allocating rights of way, traffic restrictions, services provided, regulating competing modes etc. The operators were secured under a PPP to achieve optimal operating efficiency, but contractual and operational risks between the regulators and operators had to be managed (FTA 2017:30)¹⁴⁵. Where planners use ‘BRT model contracts’ that offer a blueprint for all situations regardless of conditions and context, there is a substantial risk - in that local competencies, the culture, trust in relationships and respect for government and law can vary widely, resulting in unintended outcomes.

15.2.2. Choosing an Appropriate Contract

Bus operator contracts are typically classed as net-cost contract (NCC) and gross-cost contracts (GCC).

- In the case of an NCC, the operators carry the revenue risk, namely exposure to the risk of lower than expected ridership. Simply assigning risk to the operator, without giving them the means to manage it, is not sustainable, as was the case in Colombian medium-size cities and in the early stages in Lima. In these instances, operations were threatened with closure when operators experienced financial difficulties.
- A GCC on the other hand, places the revenue risk on the agency (City) where the agency pays the operators to supply kilometers of service to the system. However,

¹⁴³ Rizzo, M. (2017) Taken for a Ride: Grounding Neoliberalism, Precarious labour, and Public Transport in the African Metropolis

¹⁴⁴ Authors experience in Hanoi Vietnam, and Yichang China.

¹⁴⁵ FTA (2007) Report on South American Bus Rapid Transit Field Visits: Tracking the Evolution of the TransMilenio Model. Source: https://www.researchgate.net/publication/254608704_Report_on_South_American_Bus_Rapid_Transit_field_visits_Tracking_the_evolution_of_the_TransMilenio_Model Last accessed 22/03/2020

when risk transfers to the city it can impact on subsidy needs. It should be noted that GCC’s are typically a ‘price/penalty’ contract that pays the operators a fee for service, but also extracts penalties for performance lapses. This has the potential to create an adversarial relationship detrimental to developing a mutually beneficial partnership.

Classifying contracts based on ‘who takes all of the risk’ is becoming outdated, and systems are increasingly using hybrid (shared risk) models. Hybrid models act to protect operators to some extent (by covering base costs), but maintains incentives to perform and develop ridership.

If the operator carries any risk, they need to have some input to decisions that impact on their risk exposure (such as level of service and fares) and be able to work with the agency to optimize services to reach mutual objectives. For this reason, it is useful to think of a hybrid contract as a ‘partnership’ contract as explained in Figure 15.2-1 which outlines the type of contract appropriate to different circumstances, namely the experience of the operators and their ability to manage risk.

Figure 15.2-1: Deciding on Contract Types Based on Relative Capacity of the Parties

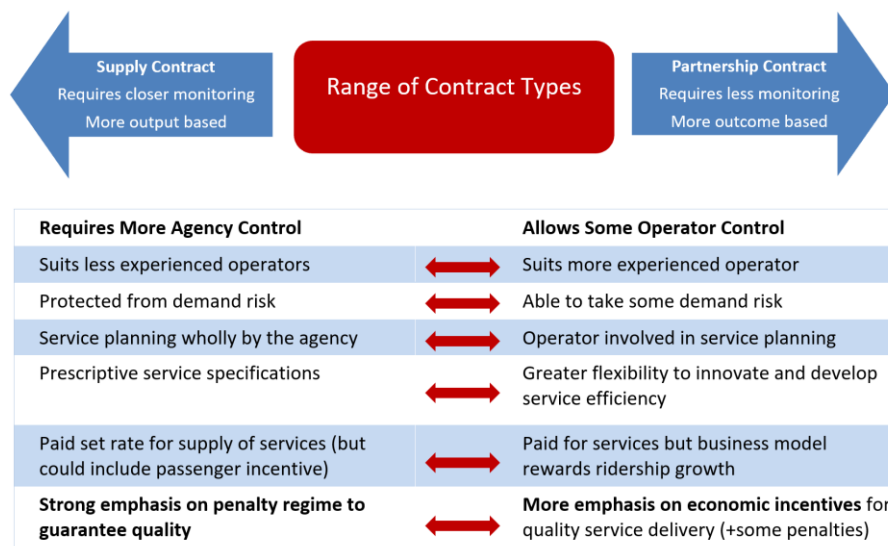

Source: Frits Olyslagers

While a more prescriptive GCC ‘supply’ contract is more suitable where operators are less experienced, *a partnership contract is more suitable when the operators have skills and experience to engage beyond simply operating buses.* In this case, operators can take a greater role, such as optimizing service planning, contributing on local knowledge of community needs, engaging in outreach and marketing, developing service opportunities, taking operational control to ensure timely operation, and organizing services to improve first/last mile access.

15.2.3. Transitioning Operators to New Contract Models

Contracting for bus operations is likely to be an entirely new experience for most developing cities. There is often an asymmetry in knowledge when negotiating with operators, whose possible lack of trust in government and concerns over loss of employment/ livelihoods etc. may cause them to withhold their cooperation. In Accra,

it took extensive trust building and consultation to successfully transition operators to the new regulatory system.

Critical to such a transition is a sound business model that can gain trust, where costs are identified, and risks properly assigned. Commercially minded operators will quickly identify the benefits of a sound business plan, perhaps as compared to their present situation. They also know that change is coming, and the status quo is not an option and hence, may be persuaded to consider alternate and viable proposals. *Therefore, the city should not be hesitant to promote change as a ‘transition to a new business opportunity’.* However, actual methodology to manage the transition process is challenging, and the city must determine what contracting strategy they adopt.

The change process, as described by Flores-Dewey and Zegras (2012) can range from ‘fostering’ to ‘forcing’ change, depending on local conditions and the level of cooperation present. Figure 15.2-2 shows a range of options adopted by different cities in transitioning to new contracts, from simply using the State-owned enterprise to operate the new system (India cases, being the status quo), through various levels of negotiations and tendering to a complete full competitive tender.

Figure 15.2-2: Methodologies used to Transition to New Contract Models

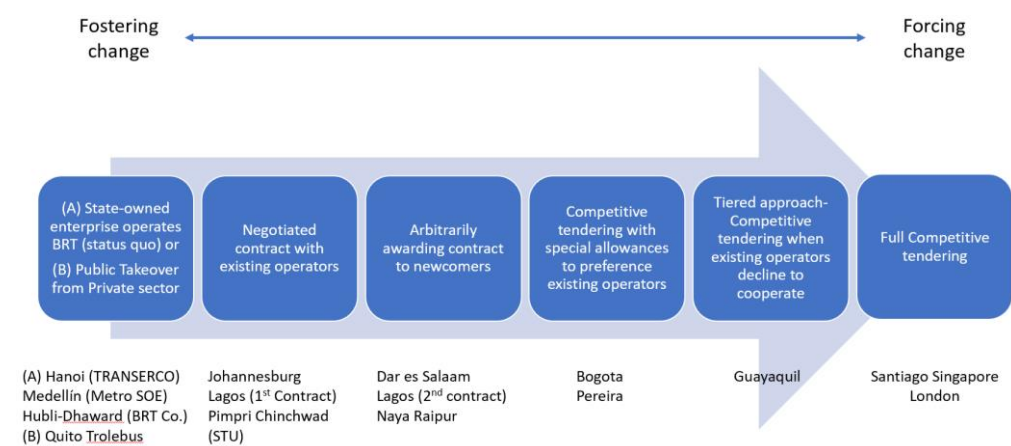

Source: Author, adapted from Flores-Dewey and Zegras (2012)

Competitive bidding to procure private sector services will often be donor or government mandated, as it is considered to be a transparent process, able to select the best-value proposal based on predetermined criteria. *However competitive tendering can be challenging for a less-than-mature market, where there may be an elevated risk of corruption, lack of transparency and industry is not equipped to understand the intricacies.* Securing the ‘right price’ is also not assured, as bid prices may be too low (resulting in a failing operator), or is too-high, due to collusion or where an operator builds-in a risk premium to cover uncertainties. Additionally, competitive bidding may not adequately deal with incumbent operators who stand to be displaced.

While cities may ideally wish for a clean change via a competitive bidding process, the reality is that the inclusion and participation of existing transport operators is usually

essential, and often, without the support of the industry sector, there is no re-organization¹⁴⁶.

Cities should avail themselves of using what they have, perhaps a state-owned bus enterprise, or a robust private industry sector and they may also need to include displaced parties into the new structure, or reorganize them into a meaningful complementary role (such as feeder services).

A **negotiated contract** is an alternative approach that is increasingly being used, as it more readily accommodates incumbent operators. But such a process requires skilled negotiation on the part of the authority, a clear understanding of Vehicle Operating Costs (VOC) and a robust OPEX model. Arguably, as unit costs are transparent, and operating risks can be appraised during negotiations, the legitimacy of the price is more assured. However, a cautionary note is for the city to avoid being captive to incumbent operators in the negotiating process and have a 'Plan B' and/or a willingness to walk away if necessary (see the tiered approach in Figure 15.2-2).

This raises the issue of unintentionally incurring extra costs in transitioning existing operators into the system. In Mexico City, where Metrobus' fostering strategy incurred costly compromises (termed by analysts as 'original sins') to engage with incumbent operators, it created ongoing problems for the business case, and a long process in correcting these compromises (Flores-Dewey and Zegras 2012:22)¹⁴⁷. These authors describe more 'forceful' strategies by Mexico City in subsequent BRT expansion, having to correct the compromises made during the initial corridor implementations. While considering that the fostering strategy may have been both necessary and inevitable, being an *unavoidable cost of initiating change in a complex urban system* (allowing it to eventually assume a more forceful posture)¹⁴⁸, they conclude that compromises can be costly and *"a healthy dose of conflict may be necessary to create a sustainable BRT"* (ibid).

Transitioning to new contracting models requires a well-designed, lengthy consultative process to introduce the contracting model. Figure 15.2-3 outlines the important areas to consider and the subsequent steps involved in the process.

The process described above is one of essentially building a trust relationship, identifying (and understanding) the operators (level of affectedness, concerns, risk condition) and developing a good understanding amongst operators of the new system to build confidence and enthusiasm. *In this process, it is critical that the city takes an active facilitation role.*

¹⁴⁶ Flores-Dewey O. and Zegras C. (2012) The costs of inclusion: Incorporating existing bus operators into Mexico City's emerging bus rapid transit system. Department of Urban Studies and Planning MIT.

¹⁴⁷ Flores-Dewey O. and Zegras C. The costs of inclusion: Incorporating existing bus operators into Mexico City's emerging bus rapid transit system. Department of Urban Studies and Planning MIT.

¹⁴⁸ The authors experience in Johannesburg BRT confirms a similar experience where the initial generous terms for the first BRT contracts were 'ring-fenced' from subsequent BRT operator negotiations, arguing that the higher price for the first contracts were for a justified risk premium, where uncertainty existed around the new system.

The city can harness positive enablers to assist implementation. In Pereira Colombia, actions to minimize social disruption, good regulation and control and the participation of existing operators in the planning process were critical enablers of the project.

It may also be worthwhile to connect with existing programs and partners such as NGO's conducting road safety or environmental programs and special interest groups such as transport or commuter associations. In Ahmedabad, the Centre of Excellence in Urban Transport University (CEPT) provided critical technical support and lent gravitas to the project.

The city needs to engage in effective communications with interested groups, address their concerns, and secure their support. This can create a positive 'force-field' around the project which significantly helps in overcoming implementation challenges. As stated earlier, considering opposing viewpoints is important, as it may uncover real concerns that need to be addressed.

Figure 15.2-3: Steps of the Transition Process



Source: WB Urban Mobility GSG Back-to-School, 2019

15.3. Leveraging BRT to Spearhead Sector Reform

BRT has been seen as an opportunity to spearhead wider reforms to formalize the passenger transport sector and rationalize operators and services. Others argue that BRT should not undertake a too-ambitious reform agenda, which may over-burden the project.

Is using BRT to spearhead industry reform a viable proposition? The answer would be that "it depends".

Both views are valid. BRT can spearhead wider reforms as government demonstrates its commitment in undertaking a large infrastructure investment, and create momentum for change. Often these reforms are essential or supportive of BRT implementation.

But caution is required, as there are complex and diverse issues which must be considered, such as: political conditions, powerful vested interests, industry capacity to manage and adapt to change, current fleet supply, technical capacity and ability to enforce standards. Simply using BRT leverage to enact sector reform, without a clear-eyed view of local conditions, could run a project into serious problems.

Another worthwhile perspective is that while BRT can provide momentum for reform, success may depend on a consistent and parallel effort to adapt industry to new practices of public transport. In Dakar Senegal, financing a bus renewal scheme was the catalyst for formalizing bus operations more than a decade ago, thus equipping them to participate in current BRT developments (see Box 1).

This suggests that while BRT could provide both the necessity and opportunity for reform, it should engage in a multi-faceted way - mindful of the intricacies, with a clear view of objectives, and with an aim to develop a sustainable business model. Carrying out sector reform initiatives independent of BRT, such as the finance and regulatory action in Dakar's case, has the advantage of growing the sector in readiness for BRT.

Box 1: Experience in Dakar Senegal

In the early 1990s in response to the declining standard of bus services, the Government of Senegal undertook a bus renewal using public sector finance to benefit private sector operators and leveraging the funding to formalize (and professionalize) bus operations. A formal system of route allocation and an official fare structure was introduced together with technical assistance and training for operators and drivers. The program was also expected to reduce pollution by offering incentives to operators to scrap old minibuses on a one-to-one basis.

Participating operators were required to form cooperatives, or economic interest groupings (EIG), which were to be collectively responsible for loan repayments, and in total involved some 245 operators, purchasing 505 buses. Operators received training in transport fleet management, financial management and drivers and ticket collectors were given instruction on customer service, route operation, and fare collection/ticket issue with monitoring carried out by CETUD- the Executive Council for Urban Transport in Dakar, who also collected operational and financial data.

Some operational challenges occurred, but overall, the bus renewal program has improved the level of transport services in the city along project corridors, and contrary to initial impressions, the improvements were more attributable to the introduction of a formal system of route allocation, and improvements in fare collection rather than to the renewal of the bus fleet itself. However, the financing of bus renewal was a necessary condition for incentivizing the operators and regulatory authority to undertake public transport reforms.¹⁴⁹

Leveraging BRT for sector reform needs a consistent and inclusive approach with all stakeholders, aiming for a 'triple win': being a 'win' for the city with a better transport system; a 'win' for customers with improved and accessible services; and a 'win' for the operators with a better and more sustainable business opportunity.

15.3.1. Engaging with the Informal Paratransit Sector

Less formal paratransit typically operates from point to point, with somewhat flexible routing and a demand-responsive service, serving both short and long trips¹⁵⁰. In many cities, paratransit has filled the gaps in urban mobility service, where government services have been withdrawn, or where they can quickly adapt to new demand created by urban sprawl. Peripheral communities rely on these informal and mostly

¹⁴⁹ Kumar A. and Christian D. (2010) The Dakar Bus Renewal Scheme – Before and after. SSATP. The International Bank for Reconstruction and Development / The World Bank. Source: www.worldbank.org/afr/ssatp

¹⁵⁰ Cervero, R., and A. Golub. 2007. Informal Transport: A Global Perspective. Journal of the World Conference on Transport Research Society: 445-457.

unregulated transport providers – typically moto taxi services and mini-buses. While such systems are usually seen as chaotic and inefficient¹⁵¹ they are deeply rooted in the community, entrepreneurial, demand responsive, relatively affordable, and often the mainstay of community transport.

Engaging with paratransit is challenging, as ownership structures are not easily identifiable and its vulnerabilities often fosters political affiliations. In some cities, the paratransit owners consist of police, government officers and even retired officials, who rent out vehicles to individual operators¹⁵². The operator workforce, while often considered ‘self-employed’ may actually be vulnerable day labor, earning ‘enough money to eat’ but unable to set long-term goals (Rizzo 2017:6.1)¹⁵³. Under a typical ‘daily rental scheme’ a driver-conductor team takes the revenue risk, and after paying for the bus rental and fuel, they live off the balance. This revenue link with driver’s income is the root cause of much of the aggressive behavior and competition for passengers.

Given the vital role of paratransit and the nature of its operations, engaging with them remains a key area to manage when introducing a BRT.

Simply decreeing that paratransit operators can form companies and become BRT operators is optimistic, although with dedicated commitment it has been achieved, albeit not without challenges¹⁵⁴. In Mexico City and in Bogotá existing bus operators and paratransit were able to be formalized to some extent, to participate in the wider system. In South Africa, Schalekamp and Behrens (2009:449)¹⁵⁵ describe the paratransit sector as a more fragmented affair, requiring a more contextual response with efforts toward greater consolidation and disaggregated negotiation, and they also (in 2010) highlighted the challenges in enacting South Africa’s National Transport Policy stating that:

“BRT in South Africa is being used as a mechanism to drive reform in the dominant yet highly fragmented paratransit sector. Thousands of paratransit operators would have to formalize their businesses, or merge into new or existing operator entities in order to participate in the new systems,” drawing attention to “insufficient consultation, an unclear future role in the system and employee redundancies ...”¹⁵⁶

Lack of capacity is also an obstacle for informal paratransit’s participation. David Mfinanga, Chairman of DART Board in Dar es Salaam highlighted the problem of lack of knowledge on forming companies and experience in operating public transport, stating that: *“In the case of DART BRT, over 90 percent of operators are not organized*

¹⁵¹ Some will argue otherwise, but efficiency declines when small capacity vehicles operate on heavily congested roads.

¹⁵² SUMATRA meeting in Dar es Salaam, attended by the author. March 2017

¹⁵³ Rizzo, M. (2017) Taken for a Ride: Grounding Neoliberalism, Precarious labour, and Public Transport in the African Metropolis

¹⁵⁴ Experience in Dar es Salaam, Cape Town and Johannesburg found that the nascent agencies found themselves in a weak negotiating position due to the critical necessity to get operators ‘on-board’.

¹⁵⁵ Schalekamp H. Behrens R. (2009) An International Review of Paratransit Regulation and International Experience: Lessons in System Rationalisation and Improvement in South African Cities. Proceedings from SATC 2009.

¹⁵⁶ Schalekamp, H. Behrens, R. (2010) Engaging Paratransit on Public Transport Reform Initiatives in South Africa: A Critique of Policy and an Investigation of Appropriate Engagement Approaches

‘management-wise’ and are not transport professionals, making it difficult for them to understand the advantages of participating in a BRT project”¹⁵⁷.

Notwithstanding the challenges, a good approach is to focus on business transition, and ‘empowering the industry’ either by 1) incorporating interested parties into a formal entity to operate the BRT as a service provider company, or 2) structuring operators into a business model that provides feeder services to the BRT.

Both options represent a business transition, engaging with operators, and where compensation to remove unwilling parties can be a last resort mechanism¹⁵⁸.

In such business transition the city needs to be an active facilitator, which is how Johannesburg and Cape Town brought in the mini-bus taxi associations for both formal BRT operations and complementary services. In Johannesburg, the city funded technical and legal expertise to support the operators during the negotiating process (McCaul and Ntuli 2011:12)¹⁵⁹. At the opening of Rea Vaya Phase 1B, Andrew Sefala, a Senior Manager with the bus operator Putco stated: *“We were working in silos but now we are learning and growing in the transport sector. Taxis are now part of the mainstream of public transport. Owners and drivers have been empowered in the process.”*¹⁶⁰

Schalekamp (2017)¹⁶¹ has produced a 5-step transition process as a follow-up work on Cape Town’s experience in building the capacity of paratransit to be part of the integrated transport system, as shown in Figure 15.3-1.

Figure 15.3-1: A 5-step transition process formalizing paratransit



Source: University of Cape Town Research

¹⁵⁷ Mfinanga D. (2012) Challenges and Opportunities for the Integration of Commuter Minibus Operators into the Dar es Salaam City BRT System CODATU Presentation (ACET). Source: <http://www.codatu.org/wp-content/uploads/3C-David-Mfinanga-CODATU-presentation-Final.pdf> Last accessed 14/01/2020

¹⁵⁸ The promise of compensation can distract from negotiations, as operators may not cooperate till ‘you show us the money’ as was the case in Dar es Salaam (authors experience).

¹⁵⁹ McCaul C. Simphiwe Ntuli S. Negotiating the Deal to enable the first Rea Vaya bus operating company Agreements, Experiences and Lessons Case Studies in Sustainable Urban Transport #7 Source: https://www.sutp.org/files/contents/documents/resources/C_Case-Studies/GIZ_SUTP_CS_Negotiating-the-Deal-Rea-Vaya_EN.pdf Last accessed 14/01/2020

¹⁶⁰ Joburg Newsroom (2013) “New shareholders sign Rea Vaya Phase 1B contract”

Source: https://www.joburg.org.za/media_/Newsroom/Pages/2016%20&%202015%20Articles/New-shareholders-sign-Rea-Vaya-Phase-1B-contract.aspx Last accessed 14/01/2020

¹⁶¹ Schalekamp, Herrie. (2017). Lessons from building paratransit operators’ capacity to be partners in Cape Town’s public transport reform process. Transportation Research Part A: Policy and Practice. 104. 58-66. 10.1016/j.tra.2017.08.002. Last accessed 14/01/2020

Not to be ignored is the possibility of incumbent operators partnering with international bus operators to introduce skilled management and technology in what is otherwise a low capacity environment. This was successful in Bogotá's case, but has failed in Johannesburg¹⁶², and to date has failed to eventuate in Dar es Salaam. Partnering with an 'outside' operator, while having clear benefits also carries issues of trust, power balance and positioning, risk exposure and so on. These arrangements are not easily made and require in-depth attention to issues of procurement and contracts. Section 15.2 outlines key issues on securing an operator.

In the case of the first BRT development in Dakar, Senegal, CETUD, the transport executive, developed the paratransit cooperatives under the Bus Renewal Scheme. Early engagement also led to the mutual acknowledgement on the lack of the local capacity in operating BRT and the proposal that the cooperatives can form a JV with an international operator where cooperatives could hold a 10%-30% equity share.

15.3.2. Integrating Paratransit as Feeder Service

BRT corridors are not adept at replacing the travel patterns offered by paratransit, nor do they penetrate well into peri-urban areas, leaving paratransit as a vital contender to connect people to mainstream transport, which at the same time, can support BRT ridership. *Disrupting established paratransit can also increase travel costs and inconvenience to passengers.* In both Dar es Salaam, and Lima, where the systems themselves had a high degree of user satisfaction, access remains a problem. In Lima the paratransit sector serves lower-density neighborhoods and hard-to-reach hilly areas and in Dar es Salaam passengers incur lengthy walk times or the need to use a high cost motorcycle taxi to reach the BRT¹⁶³.

A logical approach is to partner with paratransit, harnessing them to do what they do best – leveraging their ability to fill the gaps as feeders to the BRT and to provide complementary services in lower-demand corridors and peri-urban areas. Integrated fares and reduction in transfer costs can also improve the affordability of the system.

Integrating paratransit creates opportunity for the city to mitigate negative aspects of their operations (e.g. emissions control standards, safety and vehicle standards)¹⁶⁴.

Furthermore, with new rideshare technology, the role of paratransit can be enhanced by better connecting users to the system in a fully integrated way (such as trip planning and payment for total trip) to the BRT network. In Cape Town, the technology app 'GoMetro' maps digitizes public transport information, such as paratransit to inform passengers of travel options with a 'flexible transportation platform.'

¹⁶² Rea Vaya Report: Metropolis Peer-Review-Training Johannesburg, July 2013

¹⁶³ Chengula DH. (2017) Assessment of the Effectiveness of Dar es Salaam Bus Rapid Transit (DBRT) System in Tanzania

¹⁶⁴ Comparative Case Studies Three IDB Supported Urban Transport Projects. Executive Summary Source: WWW.IADB.Org/Evaluation

15.3.3. Engaging with Traditional Bus Services

Integrating BRT with traditional transport networks should be designed to be mutually reinforcing and therefore beneficial. Above all, the passenger wins if a more holistic network is provided. Engaging with traditional networks, restructuring bus routes and bus operator’s businesses presents an added challenge, but BRT planning cannot be isolated from its operating environment, and need to be better integrated into the overall network.

Pereira and Medellín both suffered low ridership because traditional buses were not reorganized and they operated in competition to the BRT. In Medellín the bulk of bus passengers use the conventional non-integrated services operated by some 5,000 buses, as the SITM (BRT) buses make up less than 1 percent of the bus fleet (Lobo 2019:15)¹⁶⁵.

In the early stages of Bogotá, displaced buses were assigned to other bus routes which caused excess supply, having a ‘spill-over effect’ and negating some of TransMilenio benefits (Echeverry et al. 2005: 167-169)¹⁶⁶. Furthermore, the vested interests of the traditional bus sector were influential at a political level to protect their interests (Gilbert 2008)¹⁶⁷. After Phase II, Bogotá embarked on a city-wide reform of the bus sector, restructuring and tendering routes operating in mixed traffic with the objective of improving quality of service and reduce on-road competition. Despite the challenges, the traditional urban buses now operate as a regulated, concessioned system with restructured bus routes, and operational, fare and infrastructure integration with TransMilenio’s BRT¹⁶⁸.

A successful case is the BRT (Metrobus) in La Matanza Buenos Aires, where consultations with the companies who operate 15 bus lines in the corridor, agreed on an interim arrangement for them to operate their existing routes on the BRT with an optimized frequency.

Figure 15.3-2: Bus Lines Using BRT Lanes (Argentina)



Source: Santiago Ezequiel Arias, World Bank

¹⁶⁵ Gomez-Lobo, A. 2019 BRT Reforms in Colombia: an ex-post evaluation. Source: https://www.researchgate.net/publication/333039992_BRT_Reforms_in_Colombia_an_ex-post_evaluation Last accessed 11/07/2019

¹⁶⁶ Echeverry J.C, Ibáñez A.M, Moya A.& Luis Carlos Hillón L.C. (2005) "The Economics of Transmilenio, a Mass Transit System for Bogotá," Economía Journal, The Latin American and Caribbean Economic Association - LACEA, vol. 0(Spring 20), (p167 & 169)

¹⁶⁷ Gilbert A. (2008) Bus Rapid Transit: Is Transmilenio a Miracle Cure? Transport Reviews A Transnational Transdisciplinary Journal.

¹⁶⁸ Bogota’s Bus Reform Process: Accessibility and Affordability Effects, Lessons Learned and Alternatives to Tackle Informal Services. Camila Rodriguez, etc., 2016.

15.3.4. Introducing Fleet Renewal Schemes

Fleet renewal programs are generally aimed at improving fleet quality and reducing emissions, but they are also an instigator for industry reform including formalizing operators as was the case in Dakar Senegal (Section 15.3). The methodology involves scrapping old buses to reduce oversupply and to mitigate externalities (such as pollution), or substituting them with new vehicles using compensation or economic drivers such as access to credit, or scrapping allowance fees. In some cases, late model existing buses can be incorporated into the new system, say as feeder buses or buses operating on secondary routes, but may have drawbacks in fleet consistency or lacking modern features, such as universal accessibility¹⁶⁹.

The nature of the program can either be voluntary or compulsory (or a mix of both) depending on the fleet characteristics (such as age and vehicle type and emissions standard) or requirements of the new concession arrangements.

Such a program of fleet recapitalization can also be used to empower the traditional bus sector. In South Africa, it ushered in the reform of the industry to better regulate and formalize operations to bring them into the overall framework of regulated service delivery. In Bogotá, the program was exploited by operators for financial gain, but it was necessary to achieve important reform objectives.

Bus scrapping is a complex affair, requiring clear objectives, political support, secured funding mechanisms and working with affected parties. In Lima, uncertainty about bus scrapping affected project restructuring and distracted efforts and resources from grant implementation. It is therefore advisable to de-link the vehicle scrapping program from the critical path of BRT implementation, if possible.

15.3.5. Conclusion on Sector Reform

This section has highlighted the necessity for early engagement with industry to foster reform. In such sector reform, there are no simple fixes, and each city must navigate its own situation. *'Using what you have'* is good advice and working toward mutual objectives will assist in making progress toward workable solutions. Figure 15.3-3 outlines a series of pointers that could be included in the Terms of Reference (ToR) for the preparatory work for industry reform, prior to, or early in the BRT program.

¹⁶⁹ The World Bank's Urban Mobility GSG Back to School sessions in 2010 provided an in-depth analysis on this.

Figure 15.3-3: Pointers for Engaging with Traditional Bus Operators

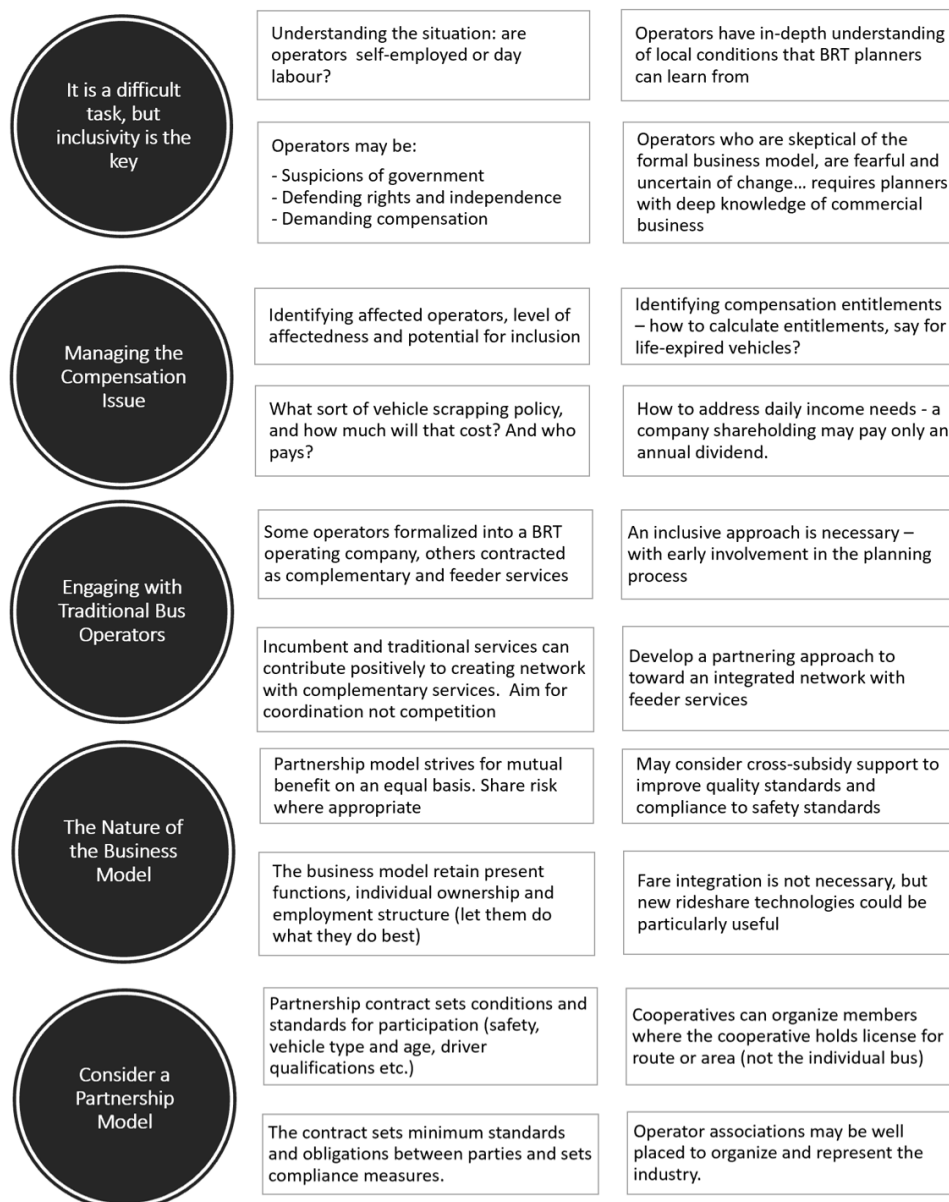

Source: Frits Olyslagers

15.4. Achieving Financial Sustainability – The Business Case

Box 2: What is Financial Sustainability ?

Financial sustainability can be broadly defined as the short and long-term financial stability of a transport system, having adequate funding to keep its core functions operating and assets renewed over the short-and long-term.

In the context of BRT, and public transport generally, financial sustainability requires satisfying funding requirements while at the same time keeping fares affordable – which is a key pricing constraint.

15.4.1. Understanding Financial Sustainability for BRT

Providing public transport services that are financially sustainable, at a level of fares that is affordable, is a struggle for most cities¹⁷⁰, having to balance financial sustainability with both transport affordability and wider social objectives. This typically involves managing and fine-tuning fare and subsidy policy and working to optimize operational efficiency. For political reasons, governments might be inclined to restrain fare increases and, in such cases, this will necessitate financial analysis at the backend, to ensure that any widening of the farebox ratio gap is covered by stable sources of funding. Recent cases where governments needed to secure funding for political or social initiatives are Bogotá (2013); London’s hopper fare (2016), and cities opting for free transit pilots (Washington DC Circulator; Kansas City).

The expectation in early BRT projects of full OPEX recovery through the farebox proved unsustainable and was perhaps a ‘too-narrow’ focus. It was also implausible to expect that public transport users would pay ‘fully-priced’ fares (covering fare collection, fleet or even infrastructure costs) while many private vehicle users pay little if any cost for the infrastructure used for their private trips.

TransMilenio’s early experience with a limited network and high efficiency allowed for farebox revenues to cover its OPEX costs¹⁷¹. Thus, when Colombia expanded BRT projects to medium-sized cities under the NUTP program, operational subsidies were not considered. The implicit (wrong) assumption was that eliminating the inefficiencies of traditional systems (over-supply of services and a redundant network route design) would fund the additional costs of the new BRT systems including the added costs of a higher standard of fleet maintenance, management and regulatory compliance (Gomez-Lobo 2019:7).

Whether this was possible or not is a moot point, as lower than expected ridership in these medium-sized cities (and also the case in India), together with the inelasticity of fares, caused financial problems to surface.

¹⁷⁰ Rodriguez, Gallego, Martinez, Montoya, Peralta (2015) Examining the implementation and labor market outcomes of targeted transit subsidies: SISBEN Subsidy for Bogotá’s Urban Poor 2015. Source <http://pubdocs.worldbank.org/en/865911454354497451/20160112-TRB-Bogota-Pro-Poor-Targeted-Subsidy-FINAL-for-Publication-00000003.pdf> Last accessed 11/07/2029

¹⁷¹ Gomez-Lobo, A. 2019 BRT Reforms in Colombia: an ex-post evaluation Source: https://www.researchgate.net/publication/333039992_BRT_Reforms_in_Colombia_an_ex-post_evaluation Last accessed 11/07/2019

Hence, for the above reasons, including the expansion to more complex networks and aspirations of city-wide coverage (in the case of Bogotá), **it is apparent that fare and ridership increases cannot always absorb all the costs.** When costs rise, and fares are inelastic (and possibly ridership is below expectations) the funding shortfall will need to be covered by additional non-farebox funding; otherwise operating costs will need to be reduced— sending the system into a negative spiral of service reduction (Gilbert 2008:456)¹⁷²

15.4.2. Achieving Financial Sustainability

Taking a ‘business approach’ in the field of public transport management, is not commonly adopted or elaborated as it is commonly thought that public transport requires subsidy. We expand the discussion to a wider appreciation of a ‘business-like’ (commercial) principles of management which can help to achieve financial performance. But ‘commercial’ does not mean ‘no subsidy’ – funding a subsidy can also be a commercial decision if it compensates for government price (fare) control or to fund non-commercial social service obligations.

A too-narrow focus on cost recovery through fares does not factor in the important role of subsidy and its value towards broad societal benefits of BRT¹⁷³. While subsidy is often branded as inefficient and loss-compensating (which may be true in some cases), a subsidy compensating for low fares is actually a ‘user-subsidy’.

Subsidy can also be viewed as a government pricing intervention which serves as an investment into good mobility outcomes and its resultant economic benefits. Van Goeverden et al. (2006)¹⁷⁴ lists four typical subsidy scenarios as:

1. Subsidies motivated by the ‘social function’ of public transport to support vulnerable groups to avoid problems of social exclusion.
2. Subsidies used as a ‘second-best’ instrument to address car related problems such as; noise, pollution, parking externalities and congestion, where direct action options are limited (‘first-best’ would be direct pricing to generate mode shift).
3. Marginal cost pricing (being welfare optimizing) leading to deficits that need to be subsidized (because public transport is characterized by economies of scale, where marginal costs are below average costs).
4. Promoting the positive externalities in public transport.

¹⁷² Gilbert A. (2008) Bus Rapid Transit: Is Transmilenio a Miracle Cure? *Transport Reviews A Transnational Transdisciplinary Journal*
Source: <http://www.informaworld.com/smpp/title~content=t713766937> Last accessed 14/01/2020

¹⁷³ In the case of Colombia, cost recovery was a worthwhile aspiration, however, the National Urban Transport Policy (as reflected, for example, in Colombian Law 380-2015) recognizes that affordable fares do not allow to internalize all costs when large external benefits are realized, especially the cost associated with formalizing the incumbent operators.

¹⁷⁴ Van Goeverden C, Rietveld P, Koelmeijer J, Peeters P. (2006) “Subsidies in public transport. Delft University of Technology. *European Transport \ Trasporti Europei* n. 32 (2006): 5-25

Source: <http://citeseerx.ist.psu.edu/viewdoc/download?doi=10.1.1.526.4244&rep=rep1&type=pdf> Last accessed 22/02/2020

However, while non-farebox revenue/or public subsidy is usually necessary, it does not imply such funding should automatically be compensating for financial losses. The use of subsidy funding must be a commercial decision based on well-grounded financial and economic analysis, structured in a way that avoids fostering subsidy dependency which reduces management focus on customer satisfaction, ridership, revenue growth and operating efficiencies.

From a business management perspective, financial sustainability requires establishing the 'business case' with management taking a business-like approach to developing the market, building ridership and revenues and efficiently managing costs.

Lower than expected ridership has been a challenge in most BRT systems where demand forecasts have not been realized (particularly at initial stages), causing financial hardship. This has placed financial pressure on operators who either carry the financial risk (LAC cases) or demand government subsidy (India cases).

On the revenue side, *'willingness-to-pay' and affordability* are key considerations as well as reaching ridership targets. While often appearing synonymous, willingness to pay is more related to a customer's perception of value, requiring fares to be reflective of market sensitivity. Affordability on the other hand, is generally measured by the percentage of the minimum wage assigned to travel costs for certain low-income groups. Affordability considerations may also be driven by political imperatives such as a defined benchmark on cost recovery (farebox ratio) which may be a performance indicator for the system.

On the cost side, the agency needs to actively work to achieve operating efficiencies to reduce wasted kilometers or inefficient services. Unit costs also need to be defined; according to a methodology that recognizes structure of labor and inputs and is adjusted according to recognized price indices.

15.4.3. Projecting Ridership and Being Realistic on Ridership Forecasts

Passenger transport planning relies heavily on demand forecasts; however, the inherent weakness of travel demand forecasting could lead to flawed projections, caused by travel demand (TD) models being too-aggregated in nature to predict location-specific routes and boarding and alighting at stations. They also lack the ability to predict behavioral or social nuances in how passengers make journey decisions. Optimism bias and insufficient assessment of risk can also play a part in influencing demand forecasts.

A better approach is to plan BRT with a practical 'ridership target' using the TD forecast as one of the reference points. The city can set annual targets (e.g. modal shift, ridership) for the initial operating years, and apply strategies to develop the market and build ridership. BRT performance in three medium-sized cities in India was primarily measured through mode shift.

In most cases, passenger demand at launch is usually well below the anticipated capacity that the system could expect to reach in the medium term. Planning should therefore take into account two discrete projections, being 1) ridership projections at launch to

ensure sufficient fleet is provided, and 2) medium to long term ridership, to ensure the system has sufficient capacity by way of infrastructure for the future. Fundamental in the planning are the strategies and marketing to grow ridership which could include:

- **Marketing and communication to identify the target market, understand varying travel needs, and to inform the design of the travel product.** This requires key ‘messaging’ to impact customer’s decisions at ‘journey level’. It is good practice to interact with user groups to explore market characteristics and needs, test design decisions, and seek feedback on operations.
- **Operations planning and optimization to deliver the right travel product.** Barranquilla and Cartagena developed better service integration using pre-trunk services to increase ridership significantly. Lima Integrated fares across trunk and feeder services.
- **Adopt an intelligent fare policy and technology applications** such as ticketing and payment systems and passenger travel information that are user-friendly. In some instances, sub-optimal fare policies can deter passengers from the system or resulted in fare leakage. Using locally suitable ticketing payment systems, allowing for a single ticketing medium to transfer between BRT and other public transport modes, and offering discounts on transfers are some of the strategies employed.

15.4.4. Taking A Business Approach

The BRT business case refers to the financial sustainability of the business. As in any public transport business, satisfying the following three factors will support the business case, *but unit costs (per km cost) remain a ‘wild card’* as discussed below¹⁷⁵:

1. Operating efficiency of the buses – based on work practices, commercial speeds’ (usually assured on a priority busway)
2. Bus Occupancy (traditionally bus operations aim for 80 percent)
3. A reasonable bus fare level (usually modelling starts with existing fares)

While traditional bus services generally have some leverage to adjust services to maintain adequate occupancy levels and optimize fleet efficiency, BRT faces a different challenge, namely, that to justify exclusive use of a busway lane, *it needs to provide a substantial service frequency to attract passengers; build market share and produce travel mode shift.* The BRT in Bucaramanga Colombia lost political support because bus lanes were seen as mostly running empty.

Supplementary funding will be required to provide an adequate level of service to attract passengers while initial ridership is low. Hanoi took such an approach, in that ridership was basically unknown prior to launch, so financial estimates were made based on various occupancy scenarios to forecast the amount of subsidy required during the period of initial operations¹⁷⁶. This allowed the calculation for the financial support

¹⁷⁵ We assume that certain elements are a ‘given’; being proper maintenance on buses, proper salaries paid, standard depot costs, the real cost of bus operation (+profit) etc. What additional cost burdens that are placed on a BRT (such as infrastructure) is also a separate question.

¹⁷⁶ Author’s work in establishing the Operational Plan in the Hanoi project.

necessary while BRT builds up ridership, and at the same time avoiding the risk of a public backlash if BRT was perceived as under-utilizing the bus lane.

However, it is incumbent on management not simply to be reliant on subsidy¹⁷⁷; it must take a business-like approach to building ridership and revenues, manage fares as a pricing mechanism to influence travel behavior - and improve the system performance and efficiency to manage costs.

In such a ‘business management’ role, the BRT agency is more of a manager than a regulator. A ‘regulator’ does not take risk, instead it manages the ‘risk-takers’; whereas a manager carries and manages some risks which also gives it greater control (by having ‘skin in the game’)¹⁷⁸. A good example is TransMilenio S.A. proactively managing demand, revenues and costs, which is arguably a key reason for its success.

As stated above, the ‘wild card’ may be the legitimacy of the per-km unit cost of bus operation. In the case of a city lacking organized public transport and transparent data on organized bus operations, obtaining the ‘right price’ through competitive tendering may be difficult. The operator (an incumbent or a new player) may exploit a knowledge /information advantage, and/or build in a risk premium to cover uncertainties, and/or gain price advantage by exploiting entry barriers that reduce competition. Critical evaluation of Vehicle Operating Costs (VOC) and developing an OPEX model would help inform the city and help mitigate risks. Figure 15.4-1 shows the components of an operational model which can forecast system profit or loss. It is not a ‘crystal ball’; but a tool used to test data inputs for critical elements of the system.

Figure 15.4-1: Input and Output of An Operations Cost (OPEX) Model

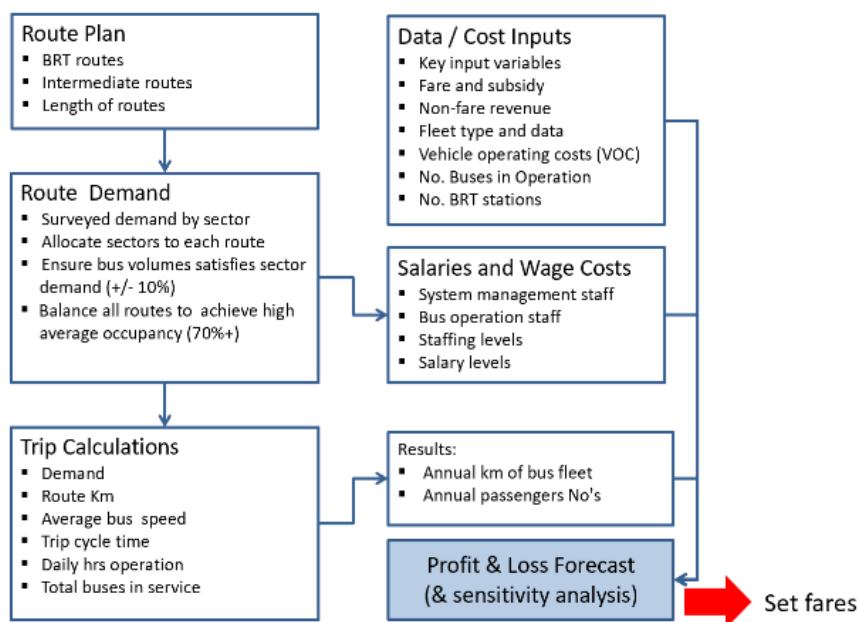

Source: Frits Olyslagers

¹⁷⁷ <https://wricitieshub.org/online-publications/83-public-transport-subsidies> LA 17/10/2019

¹⁷⁸ An aphorism meaning incurring risk (monetary or otherwise) by being involved in achieving a goal (Wikipedia)

15.5. Setting Fares and Affordability for The Poor

15.5.1. Setting Fares

Fare levels are typically in a state of tension between political/social constraints and cost recovery; however, governments generally reserve the right to set (or guide) fare policy which is understandable if they are funding subsidy.

But rather than working on a static 'affordability' benchmark (a blunt instrument), a better approach is to develop a more dynamic 'intelligent' fare policy, used as a price mechanism to influence passenger behavior and to perhaps better target a user-subsidy to manage affordability. This would require a differential fare policy, able to tap into traveler value-judgements, their travel behavior patterns and manage the nuances of affordability.

A flat fare policy applies a single tariff regardless of distance or passenger type - having the advantage of being simple and easy-to-use. In the case of Bogotá, flat fares were used to provide a progressive subsidy from short to long distance trips benefitting the poor who live on the outskirts (Hidalgo et al. 2007:21)¹⁷⁹. However, not all cities can exploit such spatial distribution. Flat fares may disadvantage short trip travelers who consider the set fare as being for a total trip, and do not see value for money in a short ride, and they will opt for cheaper alternative transport. Longer distance travelers who generally expect to pay more, receive a discount, meaning their potential 'willingness to pay' (WTP) is disregarded.

Differential fare pricing, in the forms of distance or time-based fares, and targeting user characteristics, works as a more refined price mechanism to influence travel behavior and create value for the customer. For example, discounts for frequent travel, fares based on distance or providing off-peak discounts, can unlock revenues which in turn can be used to cross-subsidize low-income groups.

An E-ticketing system, implemented in nearly all BRT case study cites, can manage more complex fare policies. The methodology is for the BRT agency to set its fares within government guidelines (e.g. an average fare), but with the flexibility to adjust pricing to generate revenue and develop the market.

15.5.2. Issues of Affordability for Low-income Groups

It is important to view affordability in the spectrum of both the financial cost that travel puts on an individual or household, as measured by the percentage of the household budget spent on transport, because although low-income households may spend less in absolute terms, the percentage burden is more acutely felt. In many cases the poor live in peri-urban areas and may indeed carry a higher travel costs of distance. It is generally regarded that for low-income populations, spending more than 10–15

¹⁷⁹ Hidalgo D. Graftieaux P. (2007) Case Study Transmilenio Bogota Colombia

percent of income on public transport constitutes a serious burden. In some developing cities, the bottom quintile spends up to 30 percent of their income on travel for work¹⁸⁰.

Two further costs should also be considered, being 1) *Generalized Cost of Transport* which takes into account shadow costs, such as discomfort, travel and waiting time, and the physical demand of travel, and 2) *Opportunity Costs*, being (in terms of time and budget): the penalty of ‘unserved trips’; that is, the disadvantage of not being able to access mobility to improve their situation, such as having access to health services or job opportunities etc. and having to forego alternative benefits such as spending on other essential items.

This highlights the need for a much deeper analysis of what ‘affordability’ means, and a more disaggregate measure of affordability across different sociodemographic groups and spatial areas of the city, so that subsidies are actually benefiting the lowest-income target group¹⁸¹.

In the case of BRT, the pressure for fares to cover OPEX costs, makes access to the system typically beyond the pockets of the poor¹⁸² thus excluding them from the benefits of improved transport. In the case of Dar es Salaam a passenger on BRT who transfers from a daladala would effectively pay double the fare of doing a similar trip in a daladala, and the cost of BRT fares can amount to *30 percent of poor people’s daily income* (Rizzo: 2019)¹⁸³. BRT commentator Dario Hidalgo recently recognized on TransMilenio that *“the 1,700 Colombian peso fare (roughly US\$1) is exorbitantly expensive for low-income users whose daily salary averages US\$3.”*¹⁸⁴. Rodriguez et al. (2015:6) observed that setting user fares close to cost recovery may have resulted in Bogotá’s lower income population being priced-out from using the system¹⁸⁵.

In 2015 the National Development Plan Law in Colombia mandated a transport user-subsidy in the National labor laws being a cash stipend paid directly to workers earning minimum wages, only.

The Inter-American Development Bank (OVE) ¹⁸⁶ highlighted that a targeted subsidy to the poor, could involve:

¹⁸⁰ Carruthers, RC.; Dick, MC.; Saurkar, A. (2005) Affordability of public transport in developing countries (English). Transport Papers; no. TP-3. Washington, DC: World Bank. <http://documents.worldbank.org/curated/en/230991468153275100/Affordability-of-public-transport-in-developing-countries>

¹⁸¹ Tomás Serebrisky, T ,Gómez-Lobo, A. Estupiñán N. and Muñoz-Raskin R. (2008) Affordability and Subsidies in Public Urban Transport: What Do We Mean, What Can Be Done? Pages 715-739 | Source: <https://doi.org/10.1080/01441640902786415>

¹⁸² Bocarejo, J.P. S. Oviedo D.R (2011) Transport Accessibility and Social Inequities: A Tool for Identification of Mobility Needs and Evaluation of Transport Investments. Journal of Transport Geography Volume 24, September 2012, Pages 142-154 Copyright © 2011 Elsevier Ltd. Source: <https://doi.org/10.1016/j.jtrangeo.2011.12.004> Last accessed 29/5/2019

¹⁸³ Rizzo M. (2019) Dar es Salaam’s new rapid bus system won international acclaim – but it excludes the poor. Source: <http://theconversation.com/dar-es-salaams-new-rapid-bus-system-won-international-acclaim-but-it-excludes-the-poor-109987>

¹⁸⁴ <https://thecityfix.com/blog/transmilenio-the-good-the-bus-and-the-ugly/>

¹⁸⁵ Rodriguez, Gallego, Martinez, Montoya, Peralta (2015) Examining the implementation and labor market outcomes of targeted transit subsidies: SISBEN Subsidyfor Bogota’sUrban Poor 2015.

¹⁸⁶ Office of Evaluation and Oversight, OVE (2016) Urban Transport and Poverty: Mobility and Accessibility effects of IDB-supported BRT systems in Cali and Lima.

- Means-tested targeting, using measurement of a household's socioeconomic level to determine eligibility for the subsidy;
- Assigned by category such as students or elderly people;
- Geographical targeting, in directing subsidy to low-income neighborhoods that have a substantial proportion of low-income households.

16. The Infrastructure and Operational Design of BRT

This section focusses on the infrastructure and operations design of the BRT system. Implementing BRT into built-environments adds layers of complexity, challenging BRT planners with competing objectives and many interfaces to manage. A limited set of priority learnings are included in this section, based on what stood out during the review of case studies and research.

Section 14	Selected Overarching Themes
Section 15	The Software of BRT: institutions, management, sector reform, financial sustainability
Section 16	The Hardware and Operations Design of BRT

Key points from Section 16 are:

- Operations planning must guide BRT design, and not carried out as an after-thought. The design of BRT as an integrated public transport network can change travel behavior and win passengers to the system. User friendliness in route design and ease of transfer are critical and requires complementary modes and integrated technologies.
- It is advised to use the BRT standard scoring system as a general reference and not as a rule book or prescriptive standard. Experience shows that cities that adapted design to their local conditions had greater success, proving that adaptation is not a 'design compromise' in the sense that it has not met the 'standards'.
- A BRT curbside alignment may be suitable where roads are narrower and bus stations/bus stops are integrated into the sidewalk, reducing the demand on road space. A BRT median alignment is less subject to operations disruptions and encroachment and is capable of higher capacity. It is also not a binary choice as a system can include both types within one system if necessary.
- A direct BRT service (off/on busway) improves integration by reducing passenger transfers and improving access to communities, but it is more suited to lower capacity systems. Direct services used in a high frequency/ high capacity setting, will see buses entering the busway randomly, causing disruption to schedules and causing station congestion.
- Non-prioritization of traffic intersection control will also affect the reliability of bus schedules and cause bus congestion at stations. BRT station designs must consider passenger requirements including convenience and safety, wayfinding, pedestrian flow and catering for passengers with special needs.
- The interface of buses docking at stations is an important design consideration.

16.1. Integrating Infrastructure, Operations and Network

The physical and operational integration of BRT as part of a public transport network, is a difficult area to manage, in part due to the unique and complex urban environments in which BRTs are built, and will usually require some trade-offs. It is good practice to establish ‘design principles’ at the start of a project, aligning with the ‘agreed objectives’ set by the city (as discussed in Section 14.3).

BRT infrastructure typically includes running ways, stations, vehicles, and systems that support the operations (Figure 16:1-1).

Figure 16-1.1: ‘Hardware’ of BRT

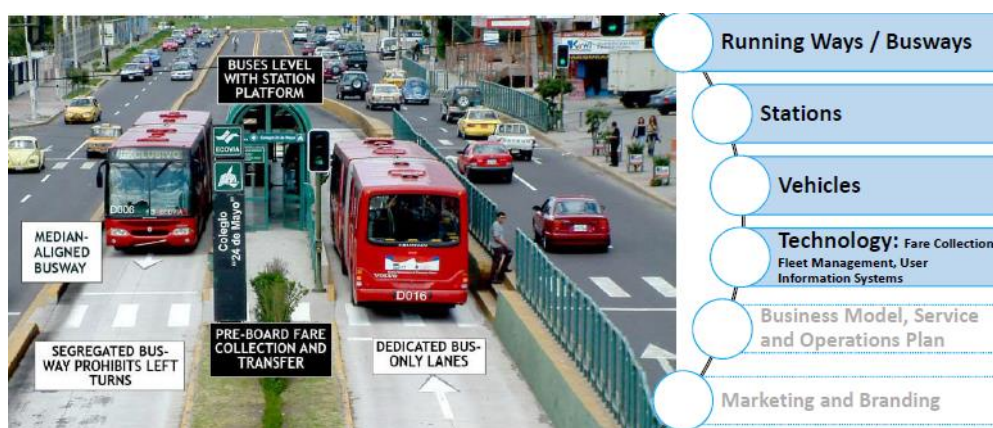

Source: WB Urban Mobility GSG Back-to-School, 2019

Operations planning is the basis upon which the design task proceeds and should not be left until it is time to operationalize the system – it is a core part of the *Concept and Feasibility Plan*, upon which the city gives approval, to initiate detailed design.

It is good practice to establish ‘design principles’ at the start of a project, aligning them with the ‘agreed objectives’ set by the city and then conduct operations planning as an iterative and convergent process. At this early stage of planning, it is critical to involve the city in all aspects of planning, as it will develop a greater sense of ownership, improving their confidence in the project, and will help ensure that timely and supportive decisions are made. The planning elements are shown in Figure 16.1-2.

Figure 16.1-2: Elements of Operations Planning

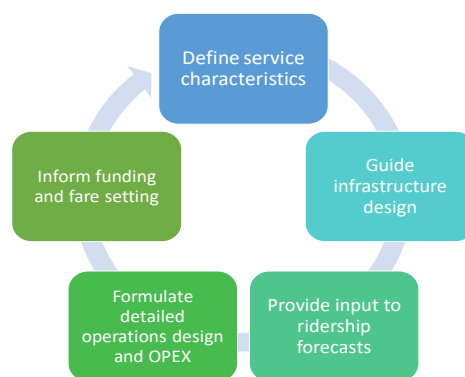

Physical and operational integration of BRT with the city’s public transport network is an integral part of the design process to develop a network. *When the BRT operation is not adequately connected with the local bus service, any gain in travel time savings on the BRT could be lost in the added passenger transfer and access time.*

Evidence from the case study cities, particularly in medium cities in Colombia was that single corridors struggled to gain enough ridership, largely due to increased waiting

time as passengers transferred from feeder to trunk services. In such cases, BRT did not fully achieve the accessibility objective and could not adequately compete with the motor car or moto-taxis for convenience.

A proper integration into the network should consider:

- Intuitive route design that passengers can easily understand;
- Good accessibility (first/last mile) to reach the system and once on the system having a choice of destinations with seamless transfers;
- Park and Ride, connected pedestrian paths, and bicycle facilities;
- Integrated fares and ticketing;
- Other supporting mobility services and technologies (rideshare/paratransit).

16.2. Assessing the BRT Standard Scoring System

The BRT Standard Scoring System, developed by ITDP, has established a gold, silver and bronze scoring system aiming to establish an internationally recognized standard for the current 'best practice' for BRT¹⁸⁷. The authors have evaluated this design criteria and acknowledge the efforts of the ITDP for its standards system which aimed to establish a common definition to improve uniformity and define good international practice.

However, a drawback in this scoring system is its dissonance with the complex and unique urban mobility conditions in each city, and the prescriptive mind-set behind 'BRT Standards'¹⁸⁸ which preferences certain design approaches that may not align well with the local conditions. For example, the decision to choose painted curbside bus lanes over segregated busways is not to be ranked or scored, rather a choice made through thoughtful analysis and debate.

A prescriptive design approach could lead to 'advocacy' with a narrow definition of BRT and its applications, resulting in a lack of proper analysis, a lack of a thorough understanding of the intertwined complex issues, and a lack of discernment of the actual design objectives. It also makes BRT decision-making very infrastructure-centric, ignoring the vital and critical aspects of the institutional framework, the policy and planning process and the political and stakeholder environment.

In real life, the 'ideal project design' is often the one that is not possible, so idealism cannot be allowed to override what can be a good practical design solution that achieves its objectives.

It is therefore advised to use the BRT scoring system as a general reference but not as a rule book or standard. Success of the BRT is its ability to efficiently meet the needs and objectives the city.

¹⁸⁷The Institute for Transportation and Development Policy, 2014. Source: <https://www.itdp.org/wp-content/uploads/2014/07/BRT-Standard-20141.pdf>

¹⁸⁸ ITDP 'The BRT standard' Source <https://www.itdp.org/2016/06/21/the-brt-standard/> LA19/10/2019

16.3. Adapting Design to Local Conditions

Some argue that a compromise of 'BRT design standards' will result in failure. Wright in Dimitrou & Gakenheimer (2011: 451-454)¹⁸⁹ takes this view, stating that the difference between 'full BRT' and 'BRT-lite' initiatives "*may well be the difference between success and failure*" in that "*for the few political leaders who take the chance to redefine their cities with full BRT, the rewards are clear*".

At face value, any design compromise for political expediency seems undesirable, yet BRT is inherently a political exercise (see Section 14.3). Ardila-Gomez (2004:202)¹⁹⁰ highlights a key advantage of BRT, seeing it as "*inherently more flexible on many dimensions than rail*", (citing Curitiba's experience) where planners were able to innovate and adjust plans, based on feedback from stakeholders. Flexibility also allows planning to adjust to political reality and permits meaningful interactions with politicians and vested interests such as bus operators. He also highlights that flexibility in the design approach is important because any plan is crafted with incomplete information - mostly on how stakeholders will respond to specific elements in the plan.

Box 3: Experience in SSA

In sub-Saharan Africa, Lagos' BRT-Lite is an unlikely success story, as it built a BRT that opted for something readily deliverable with immediate benefits in terms of bus run times, convenience and timesaving with pragmatic solutions. It carries close to 200,000 passengers per day and operates without government subsidy.

In contrast, systems in Cape Town and Johannesburg built as 'full-BRT' and ranked as Gold and Silver standard respectively, carry only 60,000 and 80,000 passengers per day and are heavily subsidy dependent.

This is not to discourage cities from building 'full' high quality BRT, and the results of any system will be due to a variety of factors and issues at play.

The La Matanza BRT in the Buenos Aires Metropolitan Area was designed with urban landscape in mind. It is designed with low platforms and side stations with three bus lanes. Pedestrians can use safe crossings along all intersections (see Figure 16-3.1).

¹⁸⁹ Dimitrou H.T. Gakenheimer R. (2011) Urban Transport in the Developing World - A Handbook of Policy and Practice. Edward Elgar Publishing. Copyright.

¹⁹⁰ Arturo Ardila Gómez. (2004) Transit planning in Curitiba and Bogotá : roles in interaction, risk, and change <http://dspace.mit.edu/handle/1721.1/28791?show=full> Last accessed 20/03/2020

Figure 16-3.1: Buenos Aires BRT (Argentina)

Source: Camila Rodriguez, World Bank

In design, ‘form must follow function’, and cities must be clear on what the design is expected to achieve and what trade-offs are being made. Designs should follow agreed design objectives, consider physical and operational constraints, achieve operational efficiency, financial sustainability and deliver a quality travel product to the passenger. In contrast, a hardline approach to BRT design may produce a system poorly adapted to the city’s requirements which then fails to reach its potential. It may have adverse impacts on the city, for example, if BRT is unduly detrimental to other traffic, the efficiency gains of BRT can be quickly lost.

Box 4: Examples of BRT Design Flexibility

- In Cartagena, pre-trunk services to the BRT TransCaribe improved access to the system, generating ridership.
- In San Francisco, it was necessary to fit BRT into the existing ROW on the city’s urban corridor (Van Ness) resulting in a design with one painted bus lane per direction and side stations over low platform. This BRT blends into the surrounding urban landscape.
- In Hanoi, the image of median BRT as a ‘middle-class’ bus system has worked well to dissuade the customary attitude that buses are used by ‘poor people’ and BRT has been able to attract private user motorcyclists.
- In Brisbane BRT, safety was a main concern (especially women), so architects took special attention to lighting and use of glass to improve personal security.

16.4. Selection of the First Corridor

The selection of the first corridor is a critical choice. Cities may be tempted to choose an easy corridor, but may find it has insufficient ridership, or alternatively, they may choose the most congested corridor and face increased implementation issues. Often the choice tends to be political, but the decision can also reflect caution, risk appetite, and perceived constraints. Consultants and advisors should understand these concerns and in consultations highlight the objectives, risks, and also what could be recommended to improve the chance of a successful outcome. *Confidence in the project can improve if there is an honest discussion on risk identification and mitigation.*

Being able to mitigate implementation risk, and demonstrating a good early result, will reduce the political risk, particularly where political capital has been expended during the construction and implementing stage.

If the system makes a good ‘first impression’ it augers well for planning the next phase. An advisable approach is to aim for ‘*maximum benefit with manageable effort*’ by selecting an important corridor which is feasible and can serve as a ‘proof of concept’ pilot and at the same time integrate a set of improvements: such as, a connected local bus network, traffic engineering and management and ITS applications for traffic and buses, in order to showcase what BRT can do and then scale up.

Integration is the key to creating a ‘maximum’ early impact, as was demonstrated in the Colombian large cities, where pre-trunk services were introduced. Single corridors appear to struggle to gain enough ridership, so actions such as direct services accessing the busway, and complementary feeder and first/last measures are an important part of the first corridor design.

16.5. Choosing Median or Curbside Alignment

The choice of curbside vs. median BRT is heavily dependent on the operating environment, and planners will need to evaluate suitability to a city’s conditions and the design objectives.

A curbside alignment may be suitable where roads are narrower, as it allows passenger facilities on the sidewalk, reducing the road space required. In Changzhi, China, the first median bus lanes were built on a narrow four-lane road but overlooked the worsening impact on vehicle and NMT traffic. The design also forced the narrowing down of general travel lanes causing road safety issues. After concerns were raised by the communities, the city amended its plans to a curbside design for other corridors.

Curbside lanes are also cheaper to build and are less intrusive (i.e. Lagos BRT Lite), however they require clear lane designation, parking elimination, defined access rights and enforcements, entry/exit to properties and other traffic engineering measures to reduce operations disruptions and encroachment. Curbside BRT also makes practical sense in corridors such as one-way streets, transit malls, or where the ROW is limited, and curbside activity is manageable. In some cases, the level of lane exclusivity could be relaxed.

The median BRT alignment might be more appropriate on roads with adequate ROWs or lanes¹⁹¹ - it provides higher bus throughput and frequency and is less subject to operations disruptions and encroachment. It has a larger impact on the urban landscape but can also:

- Present a strong mass transit image;
- Avoid interference from curb-side activity and it separates passenger activity from the curbside;

¹⁹¹ <http://documents.worldbank.org/curated/en/748591569871538781/pdf/China-CN-Changzhi-Urban-Transport.pdf>: page 19 bullet: “The bus priority lanes and stops in the first corridor - Chengxi Road - were placed in the median, ignoring the conditions of a narrow four-lane road with a high-level of vehicular and NMT traffic”

- Reduce the occurrence of pedestrian activity disrupting bus lanes; and
- Provides a single platform (bus stop) to service buses in both directions, and in some cases, where routes overlap, passengers can interchange without leaving the platform.

In the case where the BRT is predominantly a median alignment but encounters a narrower road section (a common planning occurrence), planners can face a situation where taking one lane per direction for BRT leaves only one parallel mixed traffic lane per direction (4 lanes in total), requiring a choice between:

- 1) Acquiring property to expand the ROW and build the full 6-lanes;
- 2) Operating as a 4-lane configuration leaving only one mixed traffic lane in each direction and maintain the BRT exclusivity;
- 3) Operating BRT in mixed traffic for this section;
- 4) Other innovations such as a 5-lane option with two BRT lanes on one side and the remaining 3 lanes operating as tidal flow.

The decision will be influenced by the level of traffic on the corridor and whether alternate routes for mixed traffic are available, how mixed traffic impacts on service reliability, as well as whether the city is prepared to acquire property (risking project delay). *If sentiment is against expanding the ROW, a softer and more pragmatic approach would be to operate BRT in mixed traffic; if traffic volume is moderate, and the system is not critically compromised.* However, if congestion proves too disruptive, additional segregation measures could be undertaken, for example, peak-hour bus lanes¹⁹² (see Figure 16.4-1) or area-based one-way street conversion to accommodate bus lanes. A good approach is to evaluate the pros and cons of each option, cognitive of the possibility that both types can operate in the one system.

Figure 16.4-1: Peak-Hour Bus Lanes



Source: Wenyu Jia, World Bank

¹⁹² The justification for 'bus-only' lanes in the peak hours is, that in the peak hours motorists expect congested traffic and are more accepting of bus-only lanes. However, in the off-peak, a bus lane could be seen as under-used, unnecessarily congesting the mixed traffic lane and this may cause discontent. The decision will also need to consider policing the bus lanes across the time period which may be difficult.

16.6. Choosing a Closed or Open System

The choice on the closed vs. open systems involves both infrastructure design and the service plan. The decision will be based on a range of factors such as route and network design, passenger capacity and BRT service levels, understanding that there may be trade-offs required.

A closed system operates BRT buses exclusively within the BRT lanes of the corridor. It has the following advantages:

- It provides higher speeds, frequency and capacity and is most appropriate in high density corridors, because its highly scheduled BRT trunk operation is not disrupted by the random access of buses onto the busway, which could reduce BRT capacity and reliability.
- It may allow better allocation and utilization of resources, concentrating high capacity vehicles on the trunk route where high demand exists, and services on feeder routes can be tailored to demand, also using smaller buses.
- Passengers understand the straightforward design concept of a trunk-feeder system in the same way they identify with a tram or rail line. With a limited number of trunk routes, passengers are not waiting for their specific service, as they can catch any bus to their transfer point.

However, the disadvantage is that passengers encounter forced transfers between trunk and feeder services where origins and destinations are away from the trunk lines¹⁹³, thus adding transfer time and inconvenience (with passengers paying additional costs and being faced with physical barriers, such as road crossings, footbridges, or crowded sidewalks). Where trunk-feeder systems are used, a high service frequency is required to reduce waiting times at transfer points, and transfer locations should be well designed to reduce negative transfer experiences.

Figure 16.6-1: Illustration of Closed and Open System Design

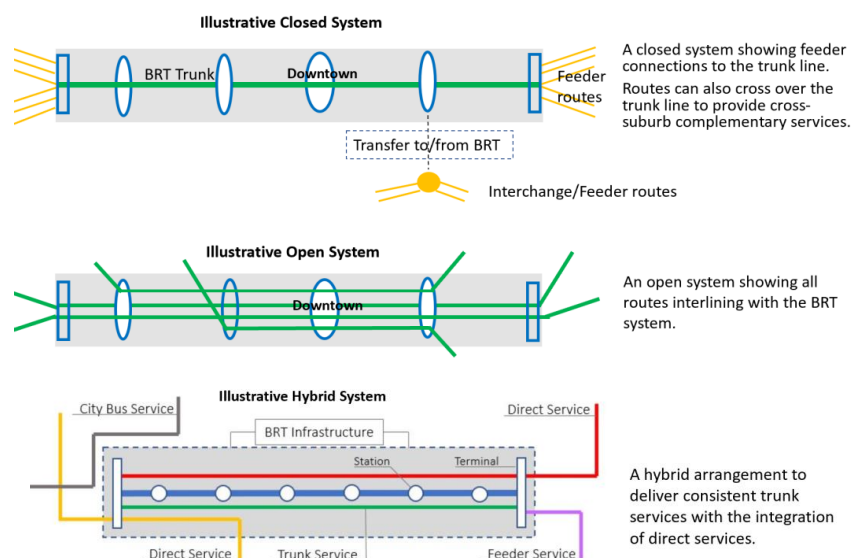

Source: Wenyu Jia, Elkin Bello, World Bank

¹⁹³ In the case of Rea Vaya, to accommodate large numbers of passengers coming off feeder lines from the Soweto suburbs, the feeder buses can access the station platforms (with same door layout as trunk buses), making a seamless transfer. This also allows the flexibility of using feeder buses for trunk services in low-demand periods.

An open system uses pre-trunk (direct) services and allows buses to enter and exit the trunk lines to function as a local service. It is typically better integrated with the general bus network, reduces passenger transfers, and penetrates into the community to provide better first and last mile access. Unlike the closed system, this design may be able to capture key origins and destinations across the city, in a more flexible way.

The downside of an open system is that the network tends to be more complex for users, and this needs to be actively managed in trip planning information.

For medium-sized cities where ridership is moderate and network complexity is manageable, direct connections with community activity centers and neighborhoods may out-weigh the needs of higher trunk line throughput (if trunk demand is not as high). In an open system design in Washington DC, scheduling slots were devised to dictate headways, prioritizing key routes, and ensuring lower priority routes enter and exit bus lanes in a controlled and coordinated manner (avoiding randomness). This effectively eliminated bus bunching in bus lanes.

The above illustrations over-simplify the closed and open system. In practice, there can also be a range of hybrid solutions as BRT is inherently flexible and local conditions may require innovation and adaptation.

In Brisbane, a hybrid arrangement has some routes dedicated to the trunk line while other routes deviate off the busway. In Stockholm Sweden, trams operate the trunk service while buses provide off-trunk and secondary services using the same stations as trams on the trunk line.

16.7. Managing Intersection Control

Intersection control is often not sufficiently prioritized in BRT design in lower capacity cities where traffic engineering is of lesser importance. Yet it is critical to maintaining the integrity of bus schedules and keeping buses properly spaced to avoid bunching. It is generally accepted that signal priority alone can save up to 15 percent in travel time for a conventional bus service.

A popular method is to redesign intersections to reduce turning phases (typically 4-phase to 2-phase) by forcing a turn left to turn right (or vice versa depending on traffic flow) and force an additional U-turn. *This should not be regarded as a simple 'go-to' solution, as in some cases it may negatively impact on the wider performance of the intersection, by imposing extra traffic movements with additional U-turns which may also need to be signalized.* If bus headways are 3 minutes or more, a 4-phase signal can manage all the turns, and BRT signal control can manage the BRT requirements.

There are five general options for intersection control (from minimum to maximum intervention) being:

1. Negotiating more green time for the BRT corridor to reduce red-light occurrence for BRT services (early Bogotá approach).
2. Extending green time for approaching buses is the most accepted practice particularly as a remedy for buses running late (Johannesburg).
3. Synchronizing bus movements to the natural green signal phase, by coordinating a BRT bus signal at the station platform to the natural green

phase at the next intersection using standard 'green-wave technology (standard block-signaling as used in rail) as planned for Dhaka.

4. ITS treatments, where the system 'tracks' buses and programs the signals to manage bus progress (late and early running). It is a 'soft' approach as it balances traffic with bus priority (Yichang China).
5. Green-light pre-emption where the bus triggers the green signal. In a heavily serviced BRT corridor it could overly disrupts signal cycles and cross traffic movements.

Of the above, 1 and 2 are soft approaches, and 3 and 4 are stronger interventions. The last option (5) is the most disruptive to road traffic, however, in corridors with low-volume cross-roads it may serve as an acceptable solution.

16.8. Designing Stations

Stations are a major point of interaction and require customer-oriented design for comfort, convenience, safety and security. Passengers wait at stations to board buses and in some cases to transfer between services. Station facilities need to include passenger information and wayfinding, walkways that are free of congestion and obstruction, easy stair inclines, universal access, and in some cases, there is opportunity to provide rest room amenities.

Platform dimensions must follow good engineering design practice to support passenger volumes and safe access. This is a challenge for BRT as physical road width is a constant restriction. The experience in Lima highlighted that in popular locations, stations need to be specified to larger dimensions to cope with the higher demand. Figures 16.8-1 and 16.8-2 show overcrowding on TransJakarta's BRT, however, this mainly occurred due to inconsistent bus schedules caused by unmanaged intersections.

Figure 16.8-1: Kalideres Station on TransJakarta



Figure 16.8-2: Dukuh Atlas Station TransJakarta



Source: Frits Olyslagers

The key factors surrounding station type and design are: ROW and traffic patterns, level of service, and forecast peak hour passenger volume. Figures 16.8-3/4 provides two illustrative designs. A complete design analysis for stations can be found at National Association of City Transportation Officials (NACTO)¹⁹⁴ A double-sided median station

¹⁹⁴ Source: <https://nacto.org/publication/transit-street-design-guide/transit-lanes-transitways/transitways/center-transitway/>

(Figure 16.8-3) requires buses with doors on the opposite side and provides same-platform transfers. The downside is that buses running in the open system would need doors on both sides to access this station. Also, the station requires more ROW to accommodate this type of design and as it serves two directions, could quickly become congested if platform size is restricted.

Figure 16.8-3: Double Sided Median Station

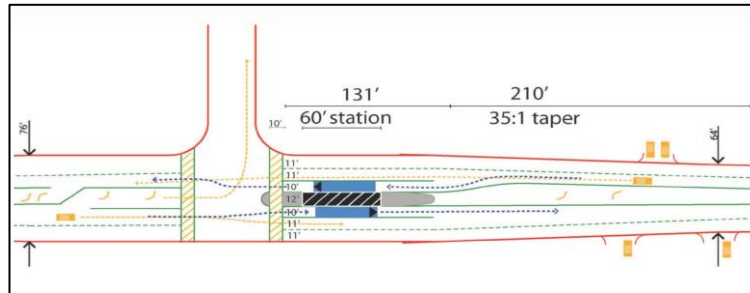

A **split median station** (Figure 16.8-4) increases platform capacity as it serves passengers in one direction only, and could be more suitable for narrower road spaces. However, this design needs to consider signal operations, turning movements, and intersection queues.

Placing the station platform at the approach side of the intersection, but placing it some distance back from the intersection could make space available for a traffic turning lane on the busway, with the turn signal programmed to clear the lane prior to the bus departing the platform.

Figure 16.8-4: Split Median Station Across intersection

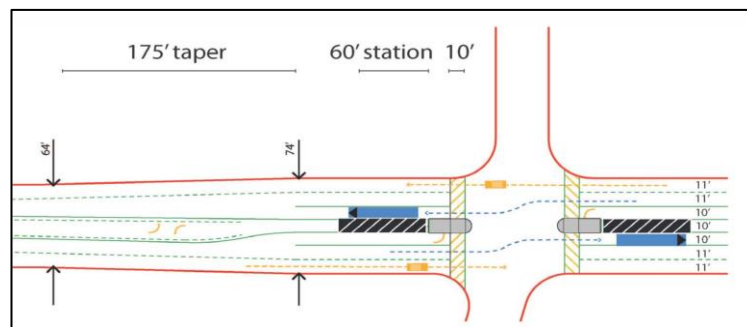

Source: Courtesy of Transportation Research Board (TRB) designed by Parsons Brinckerhoff

A constant challenge when building BRT on road corridors is the road width constraints especially where stations are located. Available solutions are limited, as most cities would be keen to avoid acquiring property and relocating utilities. Split stations in a staggered formation as shown in figure 16.8-4 above, reduces the space required by one laneway. The use of a bus guidewheel system at stations as shown in Figures 16.8-5/6 can further reduce the lane width where buses dock at stations - to 2.6 meters and also ensures accurate, predictable and stress-free docking for the bus. Dimensions for the guidewheel system is shown in Figure 16.8-7/8.

Figure 16.8-5: Curb Guidewheel

Source: <http://www.citytransport.info/OBahn.htm>

Figure 16.8-6: Precise docking with guidewheel system

Source: Frits Olyslagers

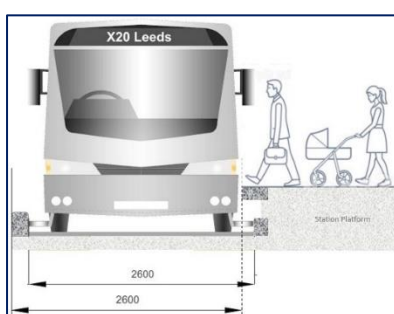
Figure 16.8-7: Schematics and dimensions of guideway system

Source: Adapted from www.londonguidedbustway.co.uk

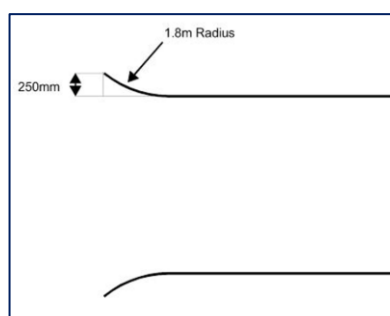
Figure 16.8-8: Splayed guiderail entry

16.9. Developing BRT in Medium-sized Cities

Medium-sized cities differ from large and mega cities in many ways, such as having smaller population size, lower density, less BRT demand, weaker institutional capacity, and less financial capacity for constructing and operating a BRT network. However, they still face urban mobility challenges, albeit on a lesser scale, and have the same requirement to transform public transport and provide mobility and accessibility to a growing population while curbing the growth of motorization.

Particularly valuable has been the intervention and support of national and central governments in BRT development in medium-sized cities. A state-led program (India cases) or a national program (Colombia cases) have been beneficial in providing funding and technical assistance for feasibility studies, system designs, and capacity building for the new start-ups, capital contributions, and helping to develop the city's institutions. Assistance was also provided in both instances to set up transport management entities to build local skill and capacity for transport management. They also ensured that wider national objectives were included, such as eligible projects aimed at environmental and other broader objectives.

Designing BRT for the city's scale and affordability. Medium-sized cities can take advantage of the inherent flexibility of BRT design and choose from the range of options (Section 14.1). One option is to consider a lower level of BRT infrastructure at less capital costs in response to a lower demand (as seen in the India cases), leaving the way open to explore lower-level BRT designs with curbside bus lanes, and if required, convert narrow streets to one-way traffic to accommodate bus lanes. Curbside bus

lanes offer greater flexibility by using sidewalk space for station facilities and when feasible, permitting traffic turns or operating in mixed traffic during the off-peak hours (Section 16.5). Operationally, the BRT can run as an open system in which BRT lines can branch into neighborhoods to provide more direct services (Section 16.6).

BRT can involve Integrated Corridor Management (ICM) where high-quality bus systems are integrated with a range of complementary improvements to deliver a range of benefits, such as access, beautification, safety measures and modified road use. In a wider sense it can leverage the capital and service improvements toward ‘placemaking’ to create a sense of community, and create opportunities for corridor economic development.

Compared with BRT, bus priority under ICM demands less cost and is less disruptive to road space, yet it gives preference to bus operations, with increased speed, reliability and user satisfaction. Several medium-sized cities with a population exceeding 1 million have already demonstrated success of ICM and bus priorities under World Bank financing, such as Changzhi, China. Currently, Freetown, the capital city of Sierra Leone, with a population of 1 million, is also implementing an ICM scheme with bus priority under World Bank financing.

Figure 16.9-1: Bus Priority and Integrated Corridor Management in Medium-Sized Cities



Source: World Bank

Land value capture to help pay for the system improvements may be attractive for medium-size cities, however potential negative impacts should be considered when implementing property or land-value taxes¹⁹⁵.

16.10. Conclusion

In summary, every BRT design element can potentially impact on the functions, operations and business model of the system. Cities need to develop a clear view of system design principles to inform the design process; planning will fail if generalized design concepts are followed. Invariably, disagreements will arise and tough decisions on the trade-offs are often needed, but a good foundational agreement on objectives could serve as a guide to sound decision-making.

¹⁹⁵ For an excellent discussion on this subject see Reference List: Using Value Capture to Finance Infrastructure and Encourage Compact Development by Rick Rybeck, District of Columbia Department of Transportation (2004).

Source: <https://journals.sagepub.com/doi/abs/10.1177/1087724X03262828> LA 17/03/2020

This page intentionally left blank

Reference List

This reference list serves as a useful resource for obtaining deeper insight and guidance into specific issues touched upon in the document. These resources have been selected for their practical application rather than academic study.

TRANSIT PLANNING

Documenting transit-planning processes in Curitiba and Bogotá from 1955-95 and 1986-2001.

Arturo Ardila- Gómez (2004) **Transit Planning in Curitiba and Bogotá - Roles in Interaction, Risk, and Change**. Source: <https://dspace.mit.edu/handle/1721.1/28791>

Key areas of transit project planning and technical decisions which are equally applicable to BRT.

Pulido, Daniel, Georges Darido, Ramon Munoz-Raskin, and Joanna Moody, editors. (2018). **The Urban Rail Development Handbook**. Washington, DC: World Bank. doi:10.1596/978-1-4648-1272-9. License: Creative Commons Attribution CC BY 3.0 IGO Source: <https://issuu.com/world.bank.publications/docs/9781464812729>

A deeper dive into the impact of BRT type reforms in intermediate cities in Colombia; impacts on overall ridership, fleet size and impacts on Generalized Cost of Transport.

Andrés Gómez-Lobo (2019) **BRT Reforms in Colombia: an ex-post evaluation**. Source: https://www.researchgate.net/publication/333039992_BRT_Reforms_in_Colombia_an_ex-post_evaluation

The importance of the planning process and project timing in defining project outcomes – an analysis of Delhi BRT and Ahmedabad BRT

Rizvi A. & Sclar E., (2014), **Implementing Bus Rapid Transit: A tale of two Indian cities**. Source: <https://www.sciencedirect.com/science/article/abs/pii/S0739885914000845> LA 2/10/2019

PRACTICAL BRT DESIGN

These publications are for technical guidance only. Practitioners must exercise their own critical analysis on applicability and practicability for local conditions.

APTA (2010) **Bus Rapid Transit Service Design**. Source: https://www.apta.com/wp-content/uploads/Standards_Documents/APTA-BTS-BRT-RP-004-10.pdf

National Academies of Sciences, Engineering, and Medicine (2007). **Bus Rapid Transit Practitioner's Guide**. Washington, DC: The National Academies Press. Source: <https://doi.org/10.17226/23172>.

NACTO (2016) **The Transit Street Design Guide** is a well-illustrated, detailed introduction to designing streets for high-quality transit, from local buses to BRT, from trams to light rail. Source: <https://nacto.org/publication/transit-street-design-guide/>

NACTO (2016) **Urban Street Design Guide** shows how streets of every size can be reimagined and reoriented to prioritize safe driving and transit, biking, walking, and public activity. Source: <https://nacto.org/publication/urban-street-design-guide/>

ENGAGING WITH PARATRANSIT and MANAGING SECTOR REFORM

Using paratransit as first-last mile feeder/ shuttle services, institutional arrangement and a Comprehensive Urban Mobility Plan

Sanskriti Menon et al. (2017) **Local Area Shuttle Services for Pune: Potential as an Intermediate Public Transport Option** (2017) SUM Net India. Source: <https://www.sumnet.in/wp-content/uploads/2018/09/Local-Area-Shuttle-Services-for-Pune.pdf>

Guidelines on managing engagement with paratransit

Schalekamp H. (2017) **Lessons from building paratransit operators' capacity to be partners in Cape Town's public transport reform process.** Transportation Research Part A: Policy and Practice Volume 104, October 2017, Pages 58-66 Source: <https://www.sciencedirect.com/science/article/pii/S0965856415302445>

Schalekamp H. Behrens R. (2009) **An International Review of Paratransit Regulation and International Experience: Lessons in System Rationalisation and Improvement in South African Cities.** Source: https://repository.up.ac.za/bitstream/handle/2263/11968/Schalekamp_International%282009%29.pdf?sequence=1&isAllowed=y

Schalekamp, H. Behrens, R. (2010) **Engaging Paratransit on Public Transport Reform Initiatives in South Africa: A Critique of Policy and an Investigation of Appropriate Engagement Approaches** Source: https://www.academia.edu/9519516/Engaging_the_paratransit_sector_in_Cape_Town_on_public_transport_reform_Progress_process_and_risks

Managing BRT impact on employment, social safeguards and a perspective on managing the transition of the informal sector.

Dave Spooner (2019) **Bus Rapid Transit (BRT) and Formalisation of Informal Public Transport - A Trade Union Negotiating Guide**, Global Labour Institute, Manchester Source: <https://global-labour.academia.edu/DaveSpooner>

TRANSIT AND IMPACTS ON THE POOR

Understanding the interaction between urban poverty and transportation – improving accessibility, mobility equity and equality.

Gail Jennings (2016) **Transport, Poverty Alleviation and the Principles of Social Justice - A literature review for the Inclusive Sustainable Transport in support of action.** Equity and Poverty (i-STEP) programme- Partnership on Sustainable Low Carbon Transport (SLoCaT) Source: https://www.researchgate.net/publication/311148936_Transport_poverty_alleviation_and_the_principles_of_social_justice_a_literature_review

An analysis of Bogotá's experience and balancing the needs for financial and social sustainability and impacts on the poor.

Camila Rodríguez Hernández & Tatiana Peralta-Quiros, 2016. **Balancing Financial Sustainability and Affordability in Public Transport: The Case of Bogotá, Colombia.** International Transport Forum Discussion Papers 2016/16, OECD Publishing. [Source: https://ideas.repec.org/p/oec/itfaab/2016-16-en.html](https://ideas.repec.org/p/oec/itfaab/2016-16-en.html)

Camila Rodriguez et al. (2015) **Examining the implementation and labor market outcomes of targeted transit subsidies: SISBEN Subsidy for Bogotá's Urban Poor**, Source: <http://pubdocs.worldbank.org/en/865911454354497451/20160112-TRB-Bogotá-Pro-Poor-Targeted-Subsidy-FINAL-for-Publication-00000003.pdf>

FLEET RENEWAL AND BUS SCRAPPING

A detailed MPA Thesis on the programme fleet renewal of mini-bus taxis in South Africa to formalise and better regulate the industry. Key issues can be drawn from this study.

Maijane Martha Baloyi, (2012) **The impact of the Taxi Recapitalisation Programme on the South African Taxi Industry : a case study of Greater Mankweng Taxi Association in Capricorn District, Limpopo Province.** Source: <http://hdl.handle.net/10386/753>

ELECTRIC BUSES

Some good references on electric propulsion technologies (Battery Electric Bus) for the technically minded.

Olli Vilppo, Joni Markkula. (2015) **Feasibility of electric buses in public transport.** Source: http://www.evs28.org/event_file/event_file/1/pfile/EVS28_Feasibility_of_electric%20buses%20in%20public_transport_%20Vilppo_Markkula.pdf

Adnane Houbbadi, Serge Pelissier, Rochdi Trigui, Eduardo Redondo-Iglesias, Tanguy Bouton. (2019) **Overview of Electric Buses deployment and its challenges related to the charging - the case study of TRANSDEV.** 32nd Electric Vehicle Symposium (EVS32), May 2019, LYON, France. 11p. hal- 02148377v. Source: <https://hal.archives-ouvertes.fr/hal-02148377v2>

LAND VALUE CAPTURE

A useful discussion on the application and considerations for Land Value Capture

Rick Rybeck (2004) **Using Value Capture to Finance Infrastructure and Encourage Compact Development.** District of Columbia Department of Transportation. Source: <https://journals.sagepub.com/doi/abs/10.1177/1087724X03262828>